

— CONSTRUCTION —

2022 FULL LINE  
PRODUCT CATALOG



[paslode.com](http://paslode.com)



[grkfasteners.com](http://grkfasteners.com)



[tapcon.com](http://tapcon.com)



[backeronrockon.com](http://backeronrockon.com)



[ramset.com](http://ramset.com)



[teksscrews.com](http://teksscrews.com)



[redheadanchoring.com](http://redheadanchoring.com)



[easyanchors.com](http://easyanchors.com)

# Table of Contents

---

## **PASLODE®**

PASLODE CORDLESS TOOLS	6-9
PASLODE PNEUMATIC TOOLS	10-17
PASLODE NAILS & ACCESSORIES & CODE REPORTS	18-23

## **GRK FASTENERS™**

R4™ MULTI-PURPOSE FRAMING & DECKING SCREWS	26-27
RSS™ RUGGED STRUCTURAL SCREWS	28-29
DECK ELITE SCREWS	30-31
FIN/TRIM™ TRIM HEAD SCREWS	32-33
RT COMPOSITE™ TRIM HEAD SCREWS	34-35
PHEINOX™ STAINLESS STEEL SCREWS	36-37
- 305 Stainless	
- 316 Marine Grade Stainless	
LOW PROFILE CABINET™ SCREWS	38-39
TOP STAR™ SHIM SCREWS	40-41
CALIBURN™ CONCRETE SCREWS	42
MSS™ METAL SIDING SCREWS	43
STAR DRIVE BITS & ACCESSORIES	44

## **TAPCON®**

TAPCON CONCRETE SCREW ANCHORS	48-49
TAPCON+ CONCRETE SCREW ANCHORS	50-51

## **RED HEAD®**

TRUBOLT® CONCRETE WEDGE ANCHORS	52-53
RED HEAD CONCRETE ANCHORS	54-55
RED HEAD A7+ ADHESIVE ANCHORS	56-57

## **RAMSET®**

RAMSET P.A.T. TOOLS & ACCESSORIES	58-59
-----------------------------------	-------

## **TEKS®**

TEKS METAL FASTENING SCREWS	60-63
-----------------------------	-------

## **BACKER-ON®, ROCK-ON®**

CEMENT BOARD SCREWS, CBS	64-65
--------------------------	-------

## **E-Z ANCOR®**

E-Z ANCOR MULTI-USE ANCHORS	66-67
-----------------------------	-------

## **WARRANTIES**

LIABILITY AND WARRANTIES	68-69
--------------------------	-------



## REPUTATION IS EVERYTHING

### INNOVATION.

You could say we invented the nailer. And you would be right. Ever since we introduced the first pneumatic nailer, cordless framing nailer, and Positive Placement® metal connector system we've continued to improve our nailers and fasteners to be the best in the business.

### QUALITY.

Paslode is committed to one thing. Excellence. We stand by our products above all else. Every Paslode product is engineered with expertise and battle-tested for realworld toughness and performance before it leaves our factory. Our decades of expertise in tool and nail manufacturing help us deliver products that stand up to the demands of the professionals who use them.

### REPUTATION.

Nail by nail. Job by job. Day after day. We build our reputation the same way our customers do—one day at a time through hard work, reliability, and dedication. That's how Paslode became the standard by which other pneumatic and cordless fastening systems are measured. Our products are the go-to tools for professionals when it comes to framing, sheathing, trim and finish applications, fencing, floor and roof decking, siding, and insulation.



Paslode

X3

adidas

Official Construction Site  
"Safe" for  
"Safe" for  
"Safe" for

# PATENTED CORDLESS TECHNOLOGY



BETTER THAN BATTERY ALONE

## LIGHTER

The power of fuel means no heavy battery. Which makes our nailers the lightest on the market.

## MORE RELIABLE

The simple combustion mechanism means fewer parts and less complicated wiring that can break.

## MORE DURABLE

Simple self-maintenance/cleaning keeps Paslode cordless nailers running for up to 200,000 shots.



C O R D L E S S

FREE 2 YEAR SERVICE PROMISE

NO QUESTIONS ASKED

We're so confident in the quality of our cordless tools that we back each one with the industry's best guarantee.

If you have a problem with one of our cordless tools, you can send it to us and we'll fix it for free.

NO QUESTIONS.

NO HASSLES.

NO COSTS.

# PASLODE® CORDLESS TOOLS FRAMING



Designed and  
Assembled in the U.S.A. 

## CORDLESS XP 30 DEGREE FRAMING NAILER

- **Power** - Fuel + Battery System delivers consistent power to drive nails flush, even into engineered lumber.
- **Performance** - Proven to withstand wear and tear like no other and drives 9,000 shots per battery charge to keep you productive all day.
- **Lightweight** - At only 7.2 lbs, the lightest cordless framing nailer on the market, even lighter than pneumatics.

### TOOL SPECIFICATIONS

<b>Model</b>	CFN325XP
<b>Part #</b>	906300
<b>Weight</b>	7.2 lbs w/battery
<b>Dimensions</b>	12"L x 4"W x 14.25"H
<b>Nail Capacity</b>	1 Strip (48 nails)
<b>Nail Range</b>	2" - 3 ¼"
<b>Nail Diameter</b>	.113 / .120 / .131
<b>Nail Type</b>	30° Paslode RounDrive® Full Head
<b>Fuel Type</b>	All-Season Fuel (part# 816008)
<b>Nails per Fuel Cell</b>	Approx. 1,200
<b>Battery</b>	Li-ion battery (part# 902654) and Charger (part# 902667)
<b>Battery Life</b>	9,000 nails per charge
<b>Warranty</b>	1-year full 5-year extended limited

# PASLODE® CORDLESS TOOLS FINISH



CORDLESS  
2 YEAR  
SERVICE  
PROMISE  
NO QUESTIONS ASKED

Designed and Assembled in the U.S.A. 

## CORDLESS 16GA ANGLED FINISH NAILER

- **Durability** - Combustion technology that's proven to last for years of everyday use and exceed 150,000 shots.
- **Productivity** - Narrow tapered body with high visibility no-mar tip and accurate depth control for a consistent, superior finish from shot 1 to shot 1,200.
- **Lightweight** - Compact and lightweight. Best-in-class weight at 4.5 lbs for greater comfort, control, access and ease of use.

### TOOL SPECIFICATIONS

<b>Model</b>	IM250A-Li2
<b>Part #</b>	916200
<b>Weight</b>	4.5 lbs w/battery
<b>Dimensions</b>	12"L x 3.5"W x 11.25"H
<b>Nail Capacity</b>	100 (2 Strips)
<b>Nail Range</b>	1 ¼" - 2 ½"
<b>Nail Type</b>	Angled 16GA - Galvanized
<b>Fuel Type</b>	Finish/Trim Fuel (part# 816007)
<b>Nails per Fuel Cell</b>	Approx. 1,200
<b>Battery</b>	Li-ion battery (part# 902654) and Charger (part #902667)
<b>Battery Life</b>	12,000 nails per charge
<b>Warranty</b>	1-year full 5-year extended limited



CORDLESS  
2 YEAR  
SERVICE  
PROMISE  
NO QUESTIONS ASKED

Designed and Assembled in the U.S.A. 

## CORDLESS 16GA STRAIGHT FINISH NAILER

- **Durability** - Combustion technology proven to exceed 150,000 shots
- **Productivity** - Consistent power from shot 1 to 1,200.
- **Lightweight** - The lightest cordless finish nailer on the market.

### TOOL SPECIFICATIONS

<b>Model</b>	IM250S-Li
<b>Part #</b>	916000
<b>Weight</b>	4.6 lbs w/battery
<b>Dimensions</b>	10.5"L x 3.5"W x 11.75"H
<b>Nail Capacity</b>	100 (2 Strips)
<b>Nail Range</b>	1 ¼" - 2 ½"
<b>Nail Type</b>	Straight 16GA - Galvanized
<b>Fuel Type</b>	Finish/Trim Fuel (part# 816007)
<b>Nails per Fuel Cell</b>	Approx. 1,200
<b>Battery</b>	Li-ion battery (part# 902654) and Charger (part #902667)
<b>Battery Life</b>	12,000 nails per charge
<b>Warranty</b>	1-year full 5-year extended limited





CORDLESS  
2 YEAR SERVICE PROMISE  
NO QUESTIONS ASKED

Designed and Assembled in the U.S.A.

## CORDLESS 18GA STRAIGHT BRAD FINISH NAILER

- **Durability** - Combustion technology proven to exceed 150,000 shots.
- **Productivity** - Consistent power from shot 1 to 1,200. Plus angled magazine to fit into tight spaces.
- **Lightweight** - The lightest cordless finish nailer on the market. At only 4.6 lbs. it gives pros greater comfort, control, and ease of use.

### TOOL SPECIFICATIONS

<b>Model</b>	IM200Li
<b>Part #</b>	918000
<b>Weight</b>	4.6 lbs w/battery
<b>Dimensions</b>	11.25"L x 3.5"W x 12"H
<b>Nail Capacity</b>	100 (2 Strips)
<b>Nail Range</b>	5/8" - 2"
<b>Nail Type</b>	18GA - Galvanized
<b>Fuel Type</b>	Finish/Trim Fuel (part# 816007)
<b>Nails per Fuel Cell</b>	Approx. 1,200
<b>Battery</b>	Li-ion battery (part# 902654) and Charger (part #902667)
<b>Battery Life</b>	12,000 nails per charge
<b>Warranty</b>	1-year full 5-year extended limited



CORDLESS  
2 YEAR SERVICE PROMISE  
NO QUESTIONS ASKED

Designed and Assembled in the U.S.A.

## CORDLESS 18GA STRAIGHT BRAD FINISH NAILER 1-STRIP

- **Maneuverable** - Able to fit in tight spaces where others can't.
- **Precise** - Drives nails flush for high quality craftsmanship.
- **Lightweight** - The lightest cordless nailer on the market makes for reduced fatigue and increased productivity.

### TOOL SPECIFICATIONS

<b>Model</b>	IM200Li.2
<b>Part #</b>	918100 (Compact Mag)
<b>Weight</b>	4.25 lbs w/battery
<b>Dimensions</b>	11"L x 3.5"W x 11.5"H
<b>Nail Capacity</b>	50 (1 Strips)
<b>Nail Range</b>	5/8" - 2"
<b>Nail Type</b>	18GA - Galvanized
<b>Fuel Type</b>	Finish/Trim Fuel (part# 816007)
<b>Nails per Fuel Cell</b>	Approx. 1,200
<b>Battery</b>	Li-ion battery (part# 902654) and Charger (part #902667)
<b>Battery Life</b>	12,000 nails per charge
<b>Warranty</b>	1-year full 5-year extended limited

# PASLODE® PNEUMATIC TOOLS

## FRAMING



Designed and Assembled in the U.S.A. 

### 30 DEGREE POWERMASTER PLUS™ FRAMING NAILER

- **Durable** - Built to last and requires less maintenance.
- **Reliable** - Consistently drives nails flush.
- **Powerful** - Proven performance on the toughest jobsites.

#### TOOL SPECIFICATIONS

<b>Model</b>	F350S
<b>Part #</b>	501000
<b>Weight</b>	8.4 lbs
<b>Dimensions</b>	19.25"L x 6.5"W x 13.25"H
<b>Nail Capacity</b>	2 Strips (84 nails)
<b>Nail Range</b>	2" - 3 1/2"
<b>Nail Diameter</b>	.113 / .120 / .131
<b>Nail Type</b>	30 Degree Paper Tape RounDrive®
<b>Operating Pressure</b>	80-120 psi (5.5 - 8.3 bar)
<b>Warranty</b>	1-year full 5-year extended limited



Designed and Assembled in the U.S.A. 

### 30 DEGREE POWERFRAMER™ FRAMING NAILER

- **Durable** - Reliable performance, minimum service.
- **Powerful** - It drives nails flush, even in LVL.
- **Lightweight** - Works faster with less fatigue.

#### TOOL SPECIFICATIONS

<b>Model</b>	PF350S
<b>Part #</b>	502000
<b>Weight</b>	7.5 lbs
<b>Dimensions</b>	18"L x 5"W x 13"H
<b>Nail Capacity</b>	2 Strips (84 nails)
<b>Nail Range</b>	2" - 3 1/2"
<b>Nail Diameter</b>	.113 / .120 / .131
<b>Nail Type</b>	30 Degree Paper Tape RounDrive®
<b>Operating Pressure</b>	80-120 psi (5.5 - 8.3 bar)
<b>Warranty</b>	1-year full 5-year extended limited



Designed and Assembled in the U.S.A. 

## 30 DEGREE COMPACT FRAMING NAILER

- **Compact** - At only 12 inches long, fits easily into tight spaces.
- **Lightweight** - Comfortable and maneuverable when working overhead.
- **Productive** - By-pass follower provides quick re-load for increased productivity.

### TOOL SPECIFICATIONS

<b>Model</b>	F325R
<b>Part #</b>	513000
<b>Weight</b>	5.9 lbs
<b>Dimensions</b>	12.3"L x 4.3"W x 12.9"H
<b>Nail Capacity</b>	1 strip (42 nails)
<b>Nail Range</b>	2" - 3¼"
<b>Nail Diameter</b>	.113 / .120 / .131
<b>Nail Type</b>	30 Degree Paper Tape RounDrive®
<b>Operating Pressure</b>	90-120 psi (6.2 - 8.3 bar)
<b>Warranty</b>	1-year full 5-year extended limited



Designed and Assembled in the U.S.A. 

## 21 DEGREE ROUND HEAD FRAMING NAILER

- **Powerful** - Drives nails flush even in the hardest wood.
- **Durable** - Designed to be long lasting.
- **Dependable** - Proven performance for tough jobsite work.

### TOOL SPECIFICATIONS

<b>Model</b>	F350-21
<b>Part #</b>	514000
<b>Weight</b>	8.1 lbs
<b>Dimensions</b>	21"L x 5"W x 13"H
<b>Nail Capacity</b>	2 strips (70 nails)
<b>Nail Range</b>	2 - 3½"
<b>Nail Diameter</b>	.113 / .120 / .131 / .148
<b>Nail Type</b>	21° Full Round Head No Debris Plastic Strip Nails
<b>Operating Pressure</b>	80-120 psi (5.5 - 8.3 bar)
<b>Warranty</b>	1-year full 5-year extended limited

# PASLODE® PNEUMATIC TOOLS

## POSITIVE PLACEMENT® & tetraGRIP™



Designed and Assembled in the U.S.A. 

### 2 1/2" POSITIVE PLACEMENT® METAL CONNECTOR NAILER

- **Fast and accurate** - The innovative Positive Placement® probe tip guides nails for unmatched hole to hole speed.
- **Versatile** - Drives both 1 1/2" and 2 1/2" Positive Placement® metal connector nails with shank diameters from .131 to .162.
- **Powerful** - Powerful motor drives nails flush, even into engineered lumber.

#### TOOL SPECIFICATIONS

<b>Model</b>	F250S-PP
<b>Part #</b>	500855
<b>Weight</b>	8.5 lbs
<b>Dimensions</b>	19.5"L x 5"W x 13.88"H
<b>Nail Capacity</b>	2 Strips (44 nails)
<b>Nail Range</b>	1 1/2" - 2 1/2"
<b>Nail Diameter</b>	.131 / .148 / .162
<b>Nail Type</b>	Positive Placement® Brite, Galvanized
<b>Operating Pressure</b>	80-120 psi (5.5 - 8.3 bar)
<b>Warranty</b>	1-year full 5-year extended limited



Designed and Assembled in the U.S.A. 

### 1 1/2" POSITIVE PLACEMENT® METAL CONNECTOR NAILER

- **Fast** - Positive Placement® probe for fastest hole to hole speed which provides widest angle of approach.
- **Accurate** - Probing tip guides nails into hardware holes.
- **Powerful** - Drives up to 1 1/2" x .148 Metal Connector Nails flush even into LVL for all day performance.

#### TOOL SPECIFICATIONS

<b>Model</b>	F150S-PP
<b>Part #</b>	515850
<b>Weight</b>	6.25 lbs
<b>Dimensions</b>	13"L x 3.7"W x 11.7"H
<b>Nail Capacity</b>	1 Strip (29 nails)
<b>Nail Range</b>	1 1/2"
<b>Nail Diameter</b>	.131 / .148
<b>Nail Type</b>	Positive Placement® Brite, Galvanized
<b>Operating Pressure</b>	90-120 psi (6.2 - 8.3 bar)
<b>Warranty</b>	1-year full 5-year extended limited



Designed and Assembled in the U.S.A.

## tetraGRIP™ SUBFLOOR FASTENING SYSTEM

- **Eliminates Nail Induced Floor Squeaks** - tetraGRIP fastener rotates as it drives to bond with the wood fibers. Use of glue between sheathing panels and floor framing is not required.
- **Reduces Builder Warranty Costs** - Fewer call backs & repair costs
- **Reduces Framing Repair Costs** - More efficient than screws and saves the framing company time and labor costs

### TOOL SPECIFICATIONS

<b>Model</b>	PF237C
<b>Part #</b>	503000
<b>Weight</b>	8.3 lbs
<b>Dimensions</b>	12.25"L x 5"W x 13.5"H
<b>Nail Capacity</b>	1 Coil (120 nails)
<b>Nail Range</b>	2 3/8"
<b>Nail Diameter</b>	.113
<b>Nail Type</b>	tetraGRIP™ 0 Degree Brite Coil Subfloor Fastener
<b>Operating Pressure</b>	90-120 psi (6.2 - 8.3 bar)
<b>Warranty</b>	1-year full 5-year extended limited



Part #	Length	Diameter	Shank	Finish	Fasteners/Coil	Coils/ Carton	Fasteners/ Carton
650605	2 3/8"	.113	Barbed	Brite	120	18	2,160



Designed and Assembled in the U.S.A.

## tetraGRIP™ SIDING COIL NAILER SYSTEM

- **Fast** - Drives as fast as a nail and has the holding power of a screw. Fast, secure installation without fastening to studs.
- **Maneuverability** - The tetraGRIP™ Coil Siding Nailer weighs in at 4.9 lbs and has a compact design for maximum maneuverability.

### TOOL SPECIFICATIONS

<b>Model</b>	TG100CSN
<b>Part #</b>	515400
<b>Weight</b>	4.9 lbs
<b>Dimensions</b>	12.25"L x 6"W x 11.5"H
<b>Nail Capacity</b>	1 coil (120 nails)
<b>Nail Range</b>	1 1/8"
<b>Nail Diameter</b>	.117
<b>Nail Type</b>	tetraGRIP™ 0 Degree Stainless Steel Coil Siding Fastener
<b>Operating Pressure</b>	90-120 psi (6.2 - 8.3 bar)
<b>Warranty</b>	1-year full 5-year extended limited



Part #	Length	Diameter	Shank	Finish	Fasteners/Coil	Coils/ Carton	Fasteners/ Carton
650867	1 1/8"	.117	Barbed	304 Stainless	120	30	3,600

# PASLODE® PNEUMATIC TOOLS FINISH



## 16GA STRAIGHT FINISH NAILER

- **Lightweight** - Optimal balance, maximum comfort, and reduced fatigue for increased productivity.
- **Consistent** - Each time the trigger is pulled, the nail drives flush into the applications.
- **Durable** - Oil-free design allows for long term, maintenance free operation which reduced associated costs.

### TOOL SPECIFICATIONS

<b>Model</b>	T250S-F16P
<b>Part #</b>	515500
<b>Weight</b>	3.9 lbs
<b>Dimensions</b>	12.3"L x 2.9"W x 11.6"H
<b>Nail Capacity</b>	2 Strips (100 nails)
<b>Nail Range</b>	1" - 2½"
<b>Nail Diameter</b>	N/A
<b>Nail Type</b>	16GA Galvanized Straight
<b>Operating Pressure</b>	80-120 psi (5.5 - 8.3 bar)
<b>Warranty</b>	1-year full 5-year extended limited



## 18GA STRAIGHT BRAD FINISH NAILER

- **Durability** - Rugged lightweight body withstands high impact even if dropped.
- **Reliability** - Professional-grade design offers consistent drive to finish the job right the first time.
- **Precision** - Smaller nose provides clear line of sight for accurate nail placement.

### TOOL SPECIFICATIONS

<b>Model</b>	T200-F18P
<b>Part #</b>	515600
<b>Weight</b>	2.9 lbs
<b>Dimensions</b>	10.04"L x 2.56"W x 10.63"H
<b>Nail Capacity</b>	2 Strips (100 nails)
<b>Nail Range</b>	⅝" - 2"
<b>Magazine Angle</b>	Straight Collation
<b>Nail Type</b>	18GA Galvanized
<b>Operating Pressure</b>	80-120 psi (5.5 - 8.3 bar)
<b>Warranty</b>	1-year full 5-year extended limited



# PASLODE® PNEUMATIC TOOLS

## STAPLERS



### 16GA STANDARD CROWN STAPLER

- **Speed** - Up to 10 staples per second.
- **Power** - Drives flush in all materials.
- **Durable** - Heavy duty all-metal magazine design.

#### TOOL SPECIFICATIONS

<b>Model</b>	SCS200
<b>Part #</b>	515700
<b>Weight</b>	5.6 lbs
<b>Dimensions</b>	15.1"L x 3.4"W x 11.7"H
<b>Magazine Capacity</b>	150 staples
<b>Staple Range</b>	3/4" - 2"
<b>Staple Type</b>	1/2" Crown 16GA Galvanized
<b>Operating Pressure</b>	80-120 psi (5.5 - 8.3 bar)
<b>Warranty</b>	1-year full 5-year extended limited



### 16GA WIDE CROWN STAPLER

- **Speed** - Up to 10 staples per second.
- **Power** - Drives flush in all materials.
- **Durable** - Heavy duty all-metal magazine design.

#### TOOL SPECIFICATIONS

<b>Model</b>	WCS200
<b>Part #</b>	515800
<b>Weight</b>	5.9 lbs
<b>Dimensions</b>	15.1"L x 3.4"W x 11.7"H
<b>Magazine Capacity</b>	150 staples
<b>Staple Range</b>	3/4" - 2"
<b>Staple Type</b>	15/16" Crown 16GA Galvanized
<b>Operating Pressure</b>	80-120 psi (5.5 - 8.3 bar)
<b>Warranty</b>	1-year full 5-year extended limited





## 18GA CAPSTAPLER

- **Convenient** - Staples and caps in one easy step.
- **Consistent Drive Performance** - Saves time on roofing felt and housewrap.
- **Easy Loading** - Open design makes staple and cap reloading a snap.

### TOOL SPECIFICATIONS

**Model** CS150

**Part #** 502575

**Weight** 4.8 lbs

**Dimensions** 15.5"L x 4"W x 10.5"H

**Staple Capacity** 90 Staples

**Cap Capacity** 1 Spool (240 Caps)

**Staple Range** 1" - 1½"

**Staple Type** 18GA ⅜" Narrow Crown

**Operating Pressure** 70-110 psi (4.8 - 7.6 bar)

**Warranty** 1-year full  
5-year extended limited

# PASLODE® FRAMING

## FUEL, NAILS & FUEL+ NAIL PACKS

### FUEL



PART #	PRODUCT	DESCRIPTION	ASSOCIATED PRODUCT(S)
816008	All-Season Framing Fuel	Drives 1,200 nails, 27 - month shelf life	906300 - CFN325XP Cordless XP Framing Nailer 905600 - CF325XP Cordless Framing Nailer 902600 - CF325Li Cordless Framing Nailer 900420 - IMCT Cordless Framing Nailer (with valve)

### FUEL + NAIL PACKS



CORDLESS FRAMING FUEL + NAIL PACKS					
Part #	Length	Diameter	Shank	Finish	#/Box
650564	2"	.113	Ring	HDG	1,000
650526	2 3/8"	.113	Ring	HDG	1,000
650522	2 3/8"	.113	Smooth	Brite	1,000
650523	2 3/8"	.113	Ring	Brite	1,000
650565	2 3/8"	.113	Ring	Brite	3,000
650527	3"	.120	Ring	*HDG	1,000
650524	3"	.120	Smooth	*Brite	1,000
650631	3"	.120	Smooth	*Brite	3,000
650525	3"	.131	Smooth	*Brite	1,000
650566	3"	.131	Smooth	*Brite	3,000
650535	3 1/4"	.131	Smooth	*Brite	1,000
650630	3 1/4"	.131	Smooth	*Brite	3,000
650615	3 1/4"	.131	Smooth	*HDG	900

Power Boost Coating

Note: 1,000 count cartons contain 1 fuel cell. 3,000 count cartons contain 3 fuel cells

# FRAMING NAILS

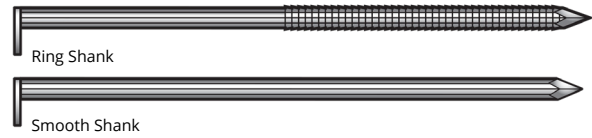
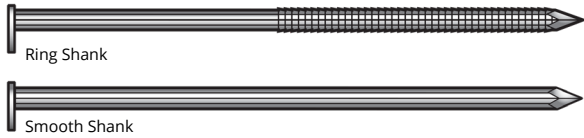

30° ROUNDRISE® FRAMING NAILS					
Part #	Length	Diameter	Shank	Finish	#/Box
650272	2"	.113	Smooth	Brite	5,500
650273	2"	.113	Ring	Brite	5,500
405253	2 ½"	.131	Smooth	Brite	3,000
650237	2 ¾"	.113	Smooth	Brite	5,000
650238	2 ¾"	.113	Ring	Brite	5,000
650836	3"	.120	Smooth	Brite	2,500
650830	3"	.131	Smooth	Brite	2,500
650839	3 ¼"	.131	Smooth	Brite	2,500
650381	2"	.113	Ring	HDG	2,000
650382	2 ¾"	.113	Smooth	HDG	2,000
650383	2 ¾"	.113	Ring	HDG	2,000
650384	3"	.120	Smooth	HDG	2,000
650385	3"	.120	Ring	HDG	2,000
650386	3"	.131	Smooth	HDG	2,000
650387	3"	.131	Ring	HDG	2,000
650388	3 ¼"	.131	Smooth	HDG	2,000
650474	3 ¼"	.131	Ring	HDG	2,000
650476	3 ½"	.131	Smooth	HDG	2,000

For use with 906300, 501000, 502000 and 513000

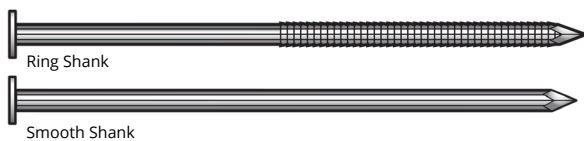

21° FULL ROUND HEAD NO DEBRIS PLASTIC STRIP NAILS					
Part #	Length	Diameter	Shank	Finish	#/Box
211322	2 ¾"	.113	Smooth	Brite	2,000
211332	2 ¾"	.113	Ring	Brite	2,000
213142	2 ½"	.131	Smooth	Brite	2,000
212062	3"	.120	Smooth	Brite	2,000
213162	3"	.131	Smooth	Brite	2,000
213182	3 ¼"	.131	Smooth	Brite	2,000

For use with 514000

D-HEAD FRAMING NAILS					
Part #	Length	Diameter	Shank	Finish	#/Box
401548	2 ¼"	.113	Smooth	Brite (Heat Treated)	4,000
097969	2 ¾"	.120	Smooth	Brite	3,500
097970	2 ¾"	.120	Ring	Brite	3,500
097973	3"	.120	Ring	Brite	3,000
097975	3"	.131	Ring	Brite	2,500
097978	3 ¼"	.131	Ring	Brite	2,500
097987	3 ½"	.131	Smooth	Brite	2,500

For use with 906300, 501000, 502000 and 513000



Positive Placement® Nail heads marked for easy identification

POSITIVE PLACEMENT® METAL CONNECTOR NAILS				
Part #	Length	Dia.	Finish	#/Box
650645	1 ½"	.131	Brite, Heat Treated	4,000 (4 boxes of 1,000 count/master carton)
650025	1 ½"	.131	Brite, Heat Treated	3,500
650646	1 ½"	.148	Brite, Heat Treated	3,500 (3 boxes of 1,000 count/master carton)
650026	1 ½"	.148	Brite, Heat Treated	3,000
650199	2 ½"	.131	Brite, Heat Treated	2,500
650027	2 ½"	.148	Brite, Heat Treated	2,500
650028	2 ½"	.162	Brite, Heat Treated	4,000
650197	1 ½"	.131	Mech. Galv, Heat Treated	3,500
650481	1 ½"	.148	Mech. Galv, Heat Treated	3,500 (4 boxes of 500 count/master carton)
650014	1 ½"	.148	Mech. Galv, Heat Treated	3,000
650106	2 ½"	.148	Mech. Galv, Heat Treated	2,500
650198	2 ½"	.162	Mech. Galv, Heat Treated	2,500

For use with 515850 ( 1 ½" ) and 500855 ( 1 ½" + 2 ½" )

# PASLODE® FINISH & EXTERIOR FUEL, NAILS, & STAPLES

## FINISH FUEL



PART #	PRODUCT	DESCRIPTION	ASSOCIATED PRODUCT(S)
<b>816007</b>	Finish/Trim Fuel (2 pack)	Drives 1,200 nails, 21 - month shelf life	916200 - Cordless 16 Ga Angled Li-ion Finish Nailer 902400 - Cordless 16 Ga Angled Li-ion Finish Nailer 916000 - Cordless 16 Ga Straight Li-ion Finish Nailer 918000 - Cordless 18 Ga Li-ion Brad Nailer 918100 - Cordless 18 Ga Straight Li-ion Brad Nailer (compact mag) 900078NT - Cordless 16 Ga Stapler (with below adapter)
<b>902550</b>	Yellow Fuel Adapter		900078NT - Cordless 16 Ga Stapler

## FINISH NAILS

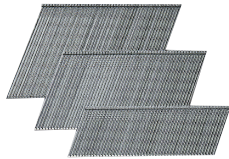

16GA ANGLED FINISH/TRIM NAILS				
Part #	Length	Gauge	Finish	Qty.
<b>650230</b>	1 ¼"	16 GA Angled	Galvanized	2,000
<b>650231</b>	1 ½"	16 GA Angled	Galvanized	2,000
<b>650046</b>	1 ¾"	16 GA Angled	Galvanized	2,000
<b>650047</b>	2"	16 GA Angled	Galvanized	2,000
<b>650232</b>	2 ½"	16 GA Angled	Galvanized	2,000

6 boxes per carton, 12,000 Qty  
For use with 902400, 900600 and 500910



18GA BRAD NAILS				
Part #	Length	Gauge	Finish	Qty.
<b>650212</b>	1"	18 GA Brad	Galvanized	2,000
<b>650213</b>	1 ¼"	18 GA Brad	Galvanized	2,000
<b>650214</b>	1 ½"	18 GA Brad	Galvanized	2,000
<b>650215</b>	2"	18 GA Brad	Galvanized	2,000

6 boxes per carton, 12,000 Qty  
For use with 918000, 918100, 515600 and 500959

16GA STRAIGHT FINISH/TRIM NAILS				
Part #	Length	Gauge	Finish	Qty.
<b>650282</b>	1 ¼"	16 GA Straight	Galvanized	2,000
<b>650283</b>	1 ½"	16 GA Straight	Galvanized	2,000
<b>650284</b>	1 ¾"	16 GA Straight	Galvanized	2,000
<b>650285</b>	2"	16 GA Straight	Galvanized	2,000
<b>650287</b>	2 ½"	16 GA Straight	Galvanized	2,000

6 boxes per carton, 12,000 Qty  
For use with 916000, 515500 and 501680

## STAPLES

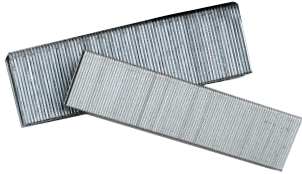

### 16GA STANDARD (1/2") CROWN STAPLES

Part #	Length	Wire	Crown	Finish	Qty.
<b>OT5240</b>	3/4"	16GA	1/2"	Galvanized	21,000
<b>OT5242</b>	1"	16GA	1/2"	Galvanized	16,500
<b>OT5243</b>	1 1/8"	16GA	1/2"	Galvanized	15,000
<b>OT5238</b>	1 1/4"	16GA	1/2"	Galvanized	13,500
<b>OT2695</b>	1 1/2"	16GA	1/2"	Galvanized	10,500
<b>OT2250</b>	1 3/4"	16GA	1/2"	Galvanized	9,000
<b>OT2258</b>	2"	16GA	1/2"	Galvanized	7,500

For use with 515700, 900078NT, and 501230



### FasCaps PLASTIC CAPS AND STAPLES

Part #	Length	Wire	Crown	Finish	Qty.
<b>650592</b>	1"	18GA	3/8"	Galvanized	10,080
<b>650597</b>	1 1/2"	18GA	3/8"	Galvanized	8,640

FasCaps are 6 inner boxes per carton

For use with 502575

### 16GA WIDE (15/16") CROWN STAPLES

Part #	Length	Wire	Crown	Finish	Qty.
<b>404068</b>	3/4"	16GA	15/16"	Galvanized	9,000
<b>404069</b>	7/8"	16GA	15/16"	Galvanized	9,000
<b>404070</b>	1"	16GA	15/16"	Galvanized	9,000
<b>404071</b>	1 1/4"	16GA	15/16"	Galvanized	9,000
<b>OT2855</b>	1 1/2"	16GA	15/16"	Galvanized	10,500
<b>650098</b>	1 3/4"	16GA	15/16"	Galvanized	9,000
<b>403471</b>	2"	16GA	15/16"	Galvanized	7,500

For use with 515800, and 501265

# PASLODE® ACCESSORIES & CODE REPORTS

## CORDLESS & PNEUMATIC

### CORDLESS BATTERIES

PART #	PRODUCT	DESCRIPTION	ASSOCIATED PRODUCT(S)
902654	Paslude Li-ion Battery	Framing: 9,000 nails per charge Finish: 12,000 nails per charge Full charge in 90 minutes	906300 - CFN325XP Cordless XP Framing Nailer 905600 - CF325XP Cordless Framing Nailer 916200 - Cordless 16 Ga Angled Li-ion Finish Nailer 902400 - Cordless 16 Ga Angled Li-ion Finish Nailer 916000 - Cordless 16 Ga Straight Li-ion Finish Nailer 918000 - Cordless 18 Ga Li-ion Brad Nailer
902667	Paslude Li-ion Battery Charger	2x faster charge time, 2 minute quick charge drives up to 200 nails	902654 - Paslude Li-ion Battery
219413	Auto Adapter Kit	Charger base and auto adapter cord	All Paslude Li-ion Tools
402500	Paslude Ni-Cd Stick Battery	2 hour charge; 4,000 staples per charge	900078NT - Cordless 16 Ga Stapler
900200	Paslude Ni-Cd Stick Battery Charger	2 hour charge time	404717 - Oval Battery 402500 - Stick Battery
900507	Auto Adapter Charger	Use with 900200 battery charger	900200 - Paslude Battery Charger
404717	Ni-Cd Battery	Drives up to 4,000 nails per charge; Recharges within 2 hours	902200 - CF325 Cordless Framing Nailer 900420 - IMCT Cordless Framing Nailer 900600 - IM250A Cordless 16 Ga Angled Finish Nailer 901000 - Cordless 18 Ga Brad Nailer 902000 - Cordless 16 Ga Straight Finish Nailer





### CORDLESS ACCESSORIES

PART #	PRODUCT	DESCRIPTION	ASSOCIATED PRODUCT(S)
219377	Cordless Li-ion Framing Tune-up Kit		905600 - CF325XP Cordless Framing Nailer 906300 - CFN325XP Cordless XP Framing Nailer 902600 - CF325Li Cordless Framing Nailer
219409	Cordless Li-ion Finish/Trim Tune-up Kit		902400 - IM250A-Li 16 Ga Angled Li-ion Finish Nailer 916000 - IM250S-Li 16 Ga Straight Li-ion Finish Nailer 918000 - IM200Li 18 Ga Straight Li-ion Brad Nailer
219348	Cordless Tool Cleaner	12oz. Bottle	All Paslude Cordless Tools
401482	Cordless Nailer Lubrication Oil	4oz. Bottle	All Paslude fuel-powered cordless nailers
902473	No-Mar Tips	3-pack - Angled	902400 - Cordless 16 Ga Angled Finish Nailer 916200 - Cordless 16 Ga Angled Li-ion Finish Nailer
219236	No-Mar Tips	3-pack - Straight	916000 - Cordless 16 Ga Straight Finish Nailer
901252	No-Mar Work Contact Element	1-pack - Framing	905600 - CF325XP Cordless Framing Nailer 906300 - CFN325XP Cordless Framing Nailer 902600 - CF325Li Cordless Framing Nailer 902200 - CF325 Cordless Framing Nailer

## PNEUMATIC ACCESSORIES

PART #	PRODUCT	DESCRIPTION	ASSOCIATED PRODUCT(S)
403720	Pneumatic Nailer Lubrication Oil	12 oz. Bottle	All Paslode pneumatic nailers
219228	No-Mar Nose	Protects wood surfaces	501000 - F350-S PowerMaster Plus

## CODE REPORTS

LISTED MANUFACTURER	PRODUCT	ESR NUMBER	QR CODE
ISANTA	Power-Driven Staples and Nails	ESR-1539	
Paslode, An Illinois Tool Works Company	Paslode Positive Placement Nails and Duo-Fast Connector Framing Nails	ESR-2126	
Paslode, An Illinois Tool Works Company	Paslode tetraGRIP nails	ESR-3071	
Paslode, An Illinois Tool Works Company	Paslode Nails	ESR-3072	
Paslode, An Illinois Tool Works Company	Paslode and Duo-Fast Galvanized Nails	ESR-3326	



# GRK<sup>®</sup> FASTENERS<sup>™</sup>

**GREATNESS AT EVERY TURN**

GRK Fasteners offers a wide selection of fasteners that includes multipurpose, structural, deck, trim, cabinet, composite and stainless screws, but they all have one thing in common—quality.

GRK Fasteners allows users to complete jobs with more productivity. Our patented W-Cut<sup>™</sup> Threadform feature reduces installation torque and allows fast driving and ease of install, the recessed Star Drive eliminates recess stripping for improved productivity, and the Zip-Tip<sup>™</sup> feature eliminates the need for pre-drilling and allows one-step installation. GRK's feature-rich screws drive jobsite productivity and allow users to keep moving from one job to the next.

GRK fasteners are corrosion resistant, approved for use in treated lumber and designed for both interior and exterior use.





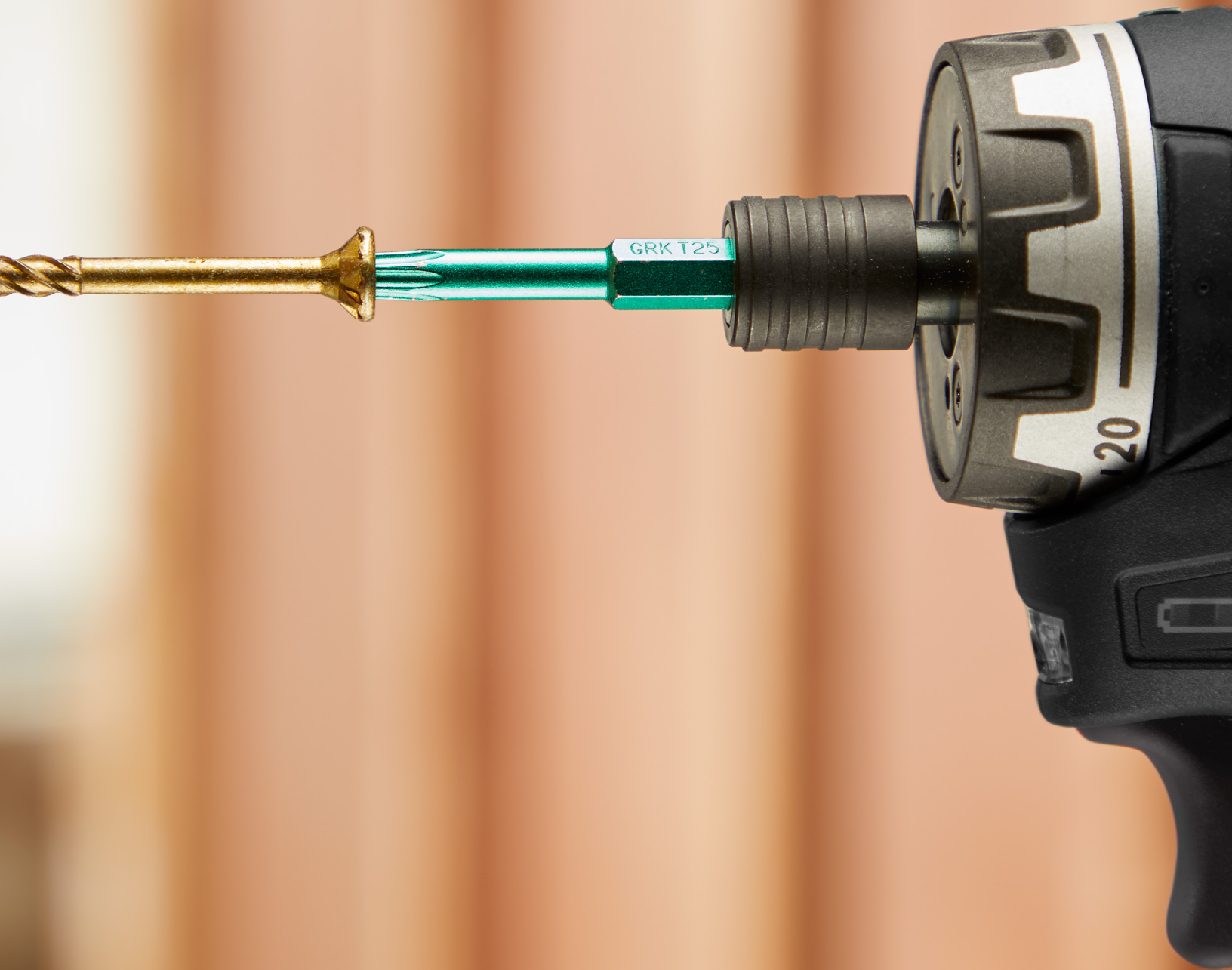

# R4™ MULTI-PURPOSE FRAMING & DECKING SCREWS



## FASTER DRIVE FOR IMPROVED PRODUCTIVITY

GRK's R4™ Multi-purpose Screw is a versatile, code-approved fastener for hundreds of applications. Its feature-rich design provides a fast and reliable connection every time.

- **Fast Bite Tip:** Provides a fast start for one-step installation
- **Zip-Tip™:** Eliminates pre-drilling
- **W-Cut™:** Low torque, faster drive
- **Precision Fit:** Reduces wobble between R4 screws and GRK bits for improved productivity<sup>1</sup>
- **CEE Thread™:** Enlarges hole to reduce splitting<sup>2</sup>
- **Star Drive Recess:** Zero stripping, with 6 points of contact
- **Underhead Cutting Teeth:** Cuts wood fiber & provides flush seating
- **GRK Head Markings:** Easy identification of genuine GRK screws
- **Climatek™ Coating:** ICC-ES AC257 code approved for use in treated lumber<sup>3</sup>
- **Code Approved:** For structural applications (see ESR-3201)<sup>4</sup>
- Some sizes also available in PHEINOX™ 305 and 316 grade Stainless Steel • For interior / exterior use



ESR-3201



AC257 Treated  
Lumber Approved

1. Precision Fit included on #9 and #10 sizes only
2. CEE Thread included on fasteners 2" and longer
3. For cedar, redwood and other naturally protected woods, GRK Pheinox™ 305 and 316 stainless steel is recommended
4. ICC Code Approval for #9, #10, and #12 sizes only

	U.S. (Std.) Size (Dia. x Length)	Bulk Part No.	Bulk Box Qty.	Contractor Packs (XL buckets) Part No.	Contractor Packs (XL buckets) Qty.	Pro- Pak Part No.	Pro-Pak Pail Qty.	Handy-Pak Part No.	Handy-Pak MC Qty./ Screw Qty. (per EA)
T-15	#6 x 1-1/4"	<b>00051</b>	13,000						
	#8 x 1-1/4"					<b>01069</b>	1,300	<b>96080</b>	4 / 110
T-15	#8 x 1-1/2"	<b>00073</b>	6,500			<b>01073</b>	1,000	<b>96085</b>	4 / 110
	#8 x 1-3/4"					<b>01075</b>	925	<b>02075</b>	20 / 100
	#8 x 2"	<b>00077</b>	4,500			<b>01077</b>	850	<b>02077</b>	20 / 100
	#8 x 2-1/2"	<b>00079</b>	3,500			<b>01079</b>	650	<b>02079</b>	20 / 100
	#9 x 1-1/4"	<b>00091</b>	8,000						
T-25	#9 x 1-1/2"	<b>00095</b>	5,200			<b>01095</b>	820	<b>02095</b>	20 / 100
	#9 x 1-3/4"	<b>00097</b>	4,500						
	#9 x 2"	<b>00099</b>	3,700	<b>120990</b>	990	<b>01099</b>	690	<b>103099</b>	4 / 110
	#9 x 2-1/2"	<b>00101</b>	2,900	<b>121010</b>	900	<b>01101</b>	575	<b>103101</b>	4 / 100
	#9 x 2-3/4"	<b>00103</b>	2,000			<b>01103</b>	480	<b>02103</b>	10 / 100
	#9 x 3-1/8"	<b>00105</b>	1,900	<b>121050</b>	720	<b>01105</b>	425	<b>103105</b>	4 / 80
	#10 x 2"	<b>00131</b>	3,200						
	#10 x 2-1/2"	<b>00133</b>	2,500			<b>01133</b>	470	<b>103133</b>	4 / 80
T-25	#10 x 2-3/4"	<b>00135</b>	2,000						
	#10 x 3-1/8"	<b>00137</b>	1,500	<b>95200</b>	630	<b>01137</b>	350	<b>103137</b>	4 / 70
	#10 x 3-1/2"	<b>00139</b>	1,200			<b>01139</b>	300	<b>02139</b>	10 / 50
	#10 x 4"	<b>00141</b>	1,000	<b>121410</b>	450	<b>01141</b>	270	<b>103141</b>	4 / 50
	#10 x 4-3/4"	<b>00143</b>	800			<b>01143</b>	230	<b>02143</b>	10 / 50
T-25	#12/14 x 5-5/8"	<b>00173</b>	600					<b>96089</b>	4 / 50
	#12/14 x 6-3/8"	<b>00177</b>	1,000					<b>02177</b>	9 / 50
	#12/14 x 8"	<b>00181</b>	500					<b>02181</b>	9 / 50



## APPLICATIONS:

- Multi-Purpose Framing
- Interior and Exterior Remodeling
- Porches and Patios
- Fencing
- Exterior Structures

- Pro-Paks need to be ordered in multiples of two
- 2" bit included in Pro-Paks. 1" bit with Handy-Paks

# RSS™ STRUCTURAL RUGGED STRUCTURAL SCREWS



## EASY TO INSTALL LAG ALTERNATIVE

GRK's RSS™ Rugged Structural Screw is a structural fastener designed for ease of installation and the strongest of connections. RSS fasteners drive into most woods without the need for pre-drilling. The specially engineered design results in a low-effort installation, especially compared to conventional lag screws.

- **Fast Bite Tip:** Provides a fast start for one-step installation
- **Zip-Tip™:** Eliminates pre-drilling<sup>1</sup>
- **W-Cut™:** Low torque, faster drive
- **Precision Fit:** Reduces wobble between RSS screws and GRK bits for improved productivity<sup>2</sup>
- **Integrated Washer Head:** Maximum clamping force
- **Star Drive Recess:** Zero stripping, with 6 points of contact
- **GRK Head Markings:** Easy identification of genuine GRK screws
- **CEE Thread™:** Enlarges hole to reduce splitting<sup>3</sup>
- **Climatek™ Coating:** ICC-ES AC257 code approved for use in treated lumber<sup>3</sup>
- **Code Approved:** For structural applications (see ESR-2442)<sup>4</sup>
- Some sizes also available in PHEINOX™ 305 and 316 grade Stainless Steel • For interior / exterior use







ESR-2442



AC257 Treated  
Lumber Approved

1. Zip-Tip included on fasteners 2-1/2" and longer
2. Precision Fit included on 5/16" sizes only
3. CEE Thread included on fasteners 3-1/8" and longer
4. For cedar, redwood and other naturally protected woods, GRK Pheinox™ 305 and 316 stainless steel is recommended
5. ICC Code Approval for 1/4", 5/16", and 3/8" sizes only

	U.S (Std.) Size (Dia. x Length)	Bulk Part No.	Bulk Box Qty.	Pro- Pak Part No.	Pro- Pak Pail Qty.	Handy- Pak Part No.	Handy-Pak MC Qty./ Screw Qty. (per EA)	RSS <sup>™</sup> Mini Handy-Pak Part No.	RSS <sup>™</sup> Mini Handy-Pak MC Qty./ Screw Qty. (per EA)	RSS <sup>™</sup> Individually Tagged Pt. No.(Qty./ Ctn.)
 T-25	#10 x 2-1/2"	<b>10133</b>	1,000			<b>12133</b>	10 / 50			
	#10 x 3-1/8"	<b>10137</b>	800	<b>11137</b>	236	<b>12137</b>	10 / 50			
 T-25	1/4" x 1-1/2"	<b>10151</b>	1,000			<b>12151</b>	20 / 50			
	1/4" x 2"	<b>10155</b>	800			<b>12155</b>	10 / 50			
	1/4" x 2-1/2"	<b>10157</b>	700							
	1/4" x 3-1/8"	<b>10161</b>	500			<b>12161</b>	10 / 50			
 T-30	5/16" x 2-1/2"	<b>10217</b>	600			<b>12217</b>	9 / 100			
	5/16" x 2-3/4"	<b>10219</b>	500			<b>12219</b>	2 / 100			
	5/16" x 3-1/8"	<b>10221</b>	500			<b>12221</b>	2 / 100	<b>14221</b>	10 / 25	<b>96001</b> (1/50)
	5/16" x 3-1/2"	<b>10223</b>	500			<b>12223</b>	2 / 100			
	5/16" x 4"	<b>10225</b>	400			<b>12225</b>	2 / 100	<b>14225</b>	10 / 25	<b>96005</b> (1/50)
	5/16" x 5-1/8"	<b>10231</b>	300			<b>12231</b>	9 / 50	<b>14231</b>	10 / 25	<b>96010</b> (1/50)
	5/16" x 6"	<b>10235</b>	300			<b>12235</b>	9 / 50	<b>14235</b>	10 / 25	<b>96015</b> (1/40)
 T-40	3/8" x 3-1/8"	<b>10273</b>	400							
	3/8" x 4"	<b>10275</b>	400			<b>12275</b>	9 / 50			
	3/8" x 6"	<b>10281</b>	300			<b>12281</b>	2 / 50			
	3/8" x 7-1/4"	<b>10285</b>	200			<b>12285</b>	2 / 50			
	3/8" x 8"	<b>10287</b>	300			<b>12287</b>	2 / 50			<b>96020</b> (1/25)
	3/8" x 10"	<b>10293</b>	300			<b>12293</b>	2 / 50			<b>96025</b> (1/25)
	3/8" x 12"	<b>10299</b>	300			<b>12299</b>	2 / 50			<b>96030</b> (1/20)
	3/8" x 14-1/8"					<b>12307</b>	2 / 50			
	3/8" x 16"	<b>10311</b>	100			<b>12311</b>	2 / 50			
<b>RSS<sup>™</sup> JTS - JOIST AND TRUSS SCREW</b>										
 T-25	1/4" x 5"					<b>93735</b>	9 / 50			
	1/4" x 6-3/4"	<b>91743</b>	300			<b>93743</b>	9 / 50			

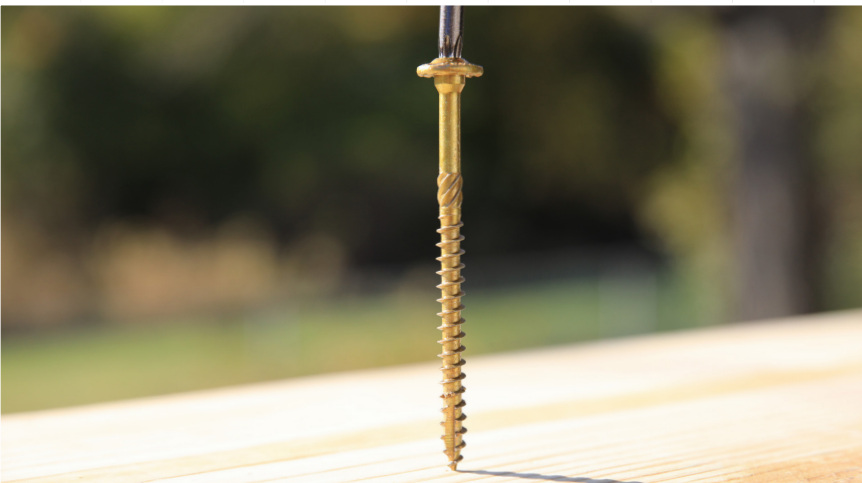

## APPLICATIONS:

- Structural Decking
- Heavy Duty Framing
- LVL Fastening
- Ledger Boards
- Multi-ply
- Interior and Exterior Remodeling

- Pro-Paks need to be ordered in multiples of two
- 2" bit included in Pro-Paks. 1" bit with Handy-Paks

# DECK ELITE

## DECKING SCREWS





## SPEED. QUALITY. ELEVATED CRAFTSMANSHIP

GRK's Deck Elite screws are designed for use in wood deck boards and provide a quick drive and clean finish. Deck Elite screws start immediately in wood with a smooth, fast drive to increase productivity on the job and the tan color of the screw provides an ideal finish.

- **Tan Color:** Provides an ideal finish
- **Fast Bite Tip:** Provides a fast start for one-step installation
- **Zip-Tip™:** Eliminates pre-drilling
- **W-Cut™:** Low torque, faster drive
- **CEE Thread™:** Enlarges hole to reduce splitting<sup>1</sup>
- **Star Drive Recess:** Zero stripping, with 6 points of contact
- **GRK Head Markings:** Easy identification of genuine GRK screws
- **Corrosion Resistant Coating:** Resists rust and keeps decks looking new
- For use in wood deck boards, fencing, and deck rails, including pressure treated lumber<sup>2</sup>
- For interior / exterior use

1. CEE Thread included on fasteners 2" and longer  
2. For cedar, redwood and other naturally protected woods, GRK Pheinox™ 305 and 316 stainless steel is recommended

	U.S (Std.) Size (Dia. x Length)	Contractor Packs (XL buckets) Part No.	Contractor Packs (XL buckets) Qty.	Pro-Pak Part No.	Pro-Pak Pail Qty.
 T-15	#8 x 2	<b>40803</b>	1,080	<b>10803</b>	540
	#9 x 1-5/8"	<b>49159</b>	1,080	<b>19159</b>	540
 T-25	#9 x 2-1/2"	<b>49212</b>	800	<b>19212</b>	400
	#9 x 3"	<b>40903</b>	700	<b>10903</b>	350

- Contractor Packs and Pro-Paks need to be ordered in multiples of two
- 2" bit included in Pro-Paks. 1" bit with Contractor Packs



## APPLICATIONS:

- Deck Boards
- Fencing
- Deck Rails

# FIN/TRIM™

## FINISHING TRIM HEAD SCREWS

### PROFESSIONAL FINISH, PROFESSIONAL LOOK

GRK's Fin/Trim™ screws are an excellent choice for most fine carpentry applications, as well as window extension jambs, joining cabinets and more. A combination of the smallest screw head available and code approved structural performance means the most secure, concealed fastening in the industry.

- **Trim Head:** Clean, finished look
- **Star Drive Recess:** Zero stripping, with 6 points of contact
- **W-Cut™:** Low torque, faster drive
- **Zip-Tip™:** Eliminates pre-drilling
- **Climatek™ Coating:** ICC-ES AC257 code approved for use in treated lumber<sup>1</sup>
- **Code Approved:** For structural applications (see ESR-3201)
- Some sizes also available in PHEINOX™ 305 and 316 grade Stainless Steel• For interior / exterior use





ESR-3201



AC257 Treated  
Lumber Approved

1. For cedar, redwood, and other naturally-protected woods, GRK recommends PHEINOX™ stainless steel fasteners



	U.S (Std.) Size (Dia. x Length)	Bulk Part No.	Bulk Box Qty.	Pro-Pak Part No.	Pro-Pak Pail Qty.	Handy-Pak Part No.	Handy-Pak MC Qty./Screw Qty. (per EA)
 <b>T-10</b>	#8 x 1-1/4"					<b>96055</b>	6 / 100
	#8 x 1-1/2"	<b>15724</b>	6,500	<b>116724</b>	600	<b>119724</b>	6 / 100
	#8 x 2"	<b>15728</b>	4,500	<b>116728</b>	510	<b>119728</b>	6 / 100
	#8 x 2-1/2"	<b>15730</b>	3,500	<b>16730</b>	605	<b>119730</b>	6 / 100
	#8 x 2-3/4"					<b>17732</b>	20 / 100
	#8 x 3-1/8"	<b>15734</b>	2,500	<b>115734</b>	300	<b>119734</b>	6 / 100
 <b>T-15</b>	#9 x 4"	<b>15760</b>	1,000			<b>117760</b>	4 / 50
	#9 x 5"	<b>15766</b>	800			<b>117766</b>	4 / 50
<b>White Fin/Trim<sup>™</sup></b>							
 <b>T-10</b>	#8 x 2"			<b>16828</b>	605	<b>96060</b>	4 / 100
	#8 x 2-1/2"			<b>16830</b>	505	<b>96065</b>	4 / 100

- Pro-Paks need to be ordered in multiples of two
- 2" bit included in Pro-Paks. 1" bit with Handy-Paks



## APPLICATIONS:

- Trim Work
- Cabinets
- Fine Carpentry

# RT COMPOSITE™

## EXTERIOR TRIM SCREW

### INSTALL RIGHT THE FIRST TIME

The RT Composite™ screw is a specially designed fastener for attaching composite and cellular PVC materials. Reverse threading under the head of the fastener helps the screw head disappear beneath the surface of the classic wood composite material while reducing or eliminating the dimple that is common in this substrate.

- **Trim Head:** Clean, finished look
- **Underhead Reverse Thread:** Reduces or eliminates mushrooming
- **Star Drive Recess:** Zero stripping, with 6 points of contact
- **W-Cut™:** Low torque, faster drive
- **Zip-Tip™:** Eliminates pre-drilling
- **Climatek™ Coating:** ICC-ES AC257 code approved for use in treated lumber<sup>1</sup>
- Available in Climatek or White Climatek coated finish
- Some sizes also available in PHEINOX™ 305 and 316 grade Stainless Steel• For interior / exterior use



ESR-3201



AC257 Treated  
Lumber Approved

1. For cedar, redwood, and other naturally-protected woods, GRK recommends PHEINOX™ stainless steel fasteners



T-10



T-15

U.S (Std.) Size (Dia. x Length)	Bulk Part No.	Bulk Box Qty.	Pro-Pak Part No.	Pro-Pak Pail Qty.	Handy-Pak Part No.	Handy-Pak MC Qty./Screw Qty. (per EA)
#8 x 2"			<b>16077</b>	725	<b>119077</b>	6 / 100
#8 x 2-1/2"	<b>15079</b>	3,500	<b>16079</b>	605	<b>119079</b>	6 / 100
#8 x 3-1/8"	<b>15083</b>	2,500	<b>16083</b>	514	<b>119083</b>	6 / 100
#9 x 2-1/2"	<b>15101</b>	2,900	<b>16101</b>	408		
#9 x 3-1/8"	<b>15105</b>	1,900	<b>16105</b>	348		

### White RT Composite™



T-10

#8 x 2"			<b>16628</b>	605	<b>17628</b>	20 / 100
#8 x 2-1/2"			<b>16630</b>	505	<b>96075</b>	4 / 100
#8 x 2-3/4"					<b>17632</b>	20 / 100
#8 x 3-1/8"					<b>17634</b>	10 / 100

- Pro-Paks need to be ordered in multiples of two
- 2" bit included in Pro-Paks. 1" bit with Handy-Paks



## APPLICATIONS:

- Exterior Trim
- cPVC Deck Boards
- Hidden Fastening Systems

# PHEINOX™ STAINLESS STEEL SCREWS

PHEINOX™ 305 CORROSION RESISTANCE FOR HIGH MOISTURE ENVIRONMENTS

PHEINOX™ 316 MARINE GRADE PROTECTION FOR SUPERIOR CORROSION RESISTANCE



GRK's PHEINOX™ line of stainless steel fasteners feature designs from R4, RSS, Fin/Trim, and RT Composite screws in corrosion and stain resistant material.

GRK recommends PHEINOX™ 305 stainless steels screws for applications that require superior corrosion resistance in exterior environments with high moisture content, such as docks, boardwalks, pools, and hot tubs. PHEINOX™ 305 stainless is also recommended for use with cedar, redwood and various other wood species that have higher acid content. PHEINOX™ 305 stainless steels screws are recommended for applications located more than 1 mile from the coast.

PHEINOX™ 316 stainless steels screws are recommended for applications where extreme corrosion resistance is necessary, such as environments with high exposure to chlorides- such as de-icing salts- and in coastal applications within 1 mile of the coast. They are also suitable for use in chemically treated wood and naturally-protected wood such as cedar and redwood.

## PHEINOX™ 305 Stainless Steel

- For use in cedar, redwood, specialty hardwood, IPE, and Mangaris
- Corrosion resistance for wet environments
- Stain resistant in specialty wood

## PHEINOX™ 316 Stainless Steel

- For use within 1 mile of the coast
- Marine-Grade protection for superior corrosion resistance
- Superior Corrosion resistance for coastal environments
- Stain resistant in specialty wood











ESR-2442



ESR-3201



AC257 Treated  
Lumber Approved

	U.S (Std.) Size (Dia. x Length)	Bulk Part No.	Bulk Box Qty.	Pro-Pak Part No.	Pro-Pak Pail Qty.	Handy-Pak Part No.	Handy-Pak MC Qty./Screw Qty. (per EA)
	<b>R4™ Screws: PHEINOX™ 305</b>						
 T-25	#10 x 2-1/2"	<b>25133</b>	2,500	<b>61633</b>	240	<b>61733</b>	4 / 80
	#10 x 3-1/8"	<b>25137</b>	1,500	<b>61637</b>	210	<b>61737</b>	4 / 70
	<b>RSS™ Screws: PHEINOX™ 305</b>						
 T-30	5/16" x 3-1/8"	<b>30221</b>	500			<b>62225</b>	4 / 45
	5/16" x 4"	<b>30225</b>	400			<b>132231</b>	4 / 40
	5/16" x 5-1/8"						
	5/16" x 6"	<b>30235</b>	300				
	<b>RT COMPOSITE™ Trim Screws: PHEINOX™ 305</b>						
 T-10	#8 x 2"			<b>36077</b>	600		
	#8 x 2-1/2"	<b>35079</b>	3,500	<b>36079</b>	560	<b>37079</b>	20 / 100
 T-15	#9 x 2-1/2"			<b>36101</b>	365		
	<b>FIN / TRIM™ Screws: PHEINOX™ 305</b>						
 T-10	#8 x 1-1/2"					<b>37724</b>	20 / 100
	#8 x 2"			<b>61728</b>	510	<b>67728</b>	6 / 100
	#8 x 2-1/2"			<b>61730</b>	420	<b>67730</b>	6 / 100
	#8 x 3-1/8"			<b>36734</b>	385	<b>37734</b>	10 / 100
 T-15	#9 x 2-1/2"			<b>36752</b>	365		
	<b>R4™ Screws: PHEINOX™ 316</b>						
 T-25	#10 x 2-1/2"					<b>137133</b>	4 / 80
	#10 x 3-1/8"					<b>137147</b>	4 / 70
	<b>FIN / TRIM™ Screws: PHEINOX™ 316</b>						
 T-10	#8 x 2-1/2"					<b>147730</b>	6 / 100

• 2" bit included in Pro-Paks. 1" bit with Handy-Paks



## APPLICATIONS:

- Boardwalks
- Pool Decks
- Spas

# LOW PROFILE CABINET™

## CABINET SCREWS



## QUICK AND SECURE INSTALLATION

GRK's Cabinet screws are designed for use in cabinet construction and installation. Cabinet screws are manufactured in a #8 gauge (4 mm) diameter for universal size convenience.

- **Star Drive Recess:** Zero stripping, with 6 points of contact
- **Zip-Tip™:** Eliminates pre-drilling<sup>1</sup>
- **W-Cut™:** Low torque, faster drive
- **Washer Head:** Creates a flush, clean hold for a strong and secure installation
- **Climatek™ Coating:** ICC-ES AC257 code approved for use in treated lumber<sup>2</sup>
- **White Cabinet Coating:** Color matched for interior applications
- For interior / exterior<sup>3</sup> use



**AC257 Treated  
Lumber Approved**

1. Zip-Tip included on fasteners 1-1/4" and longer
2. For cedar, redwood, and other naturally-protected woods, GRK recommends PHEINOX™ stainless steel fasteners
3. White Cabinet Coating only suitable for interior use



T-15

U.S (Std.) Size (Dia. x Length)	Bulk Part No.	Bulk Box Qty.	Pro-Pak Part No.	Pro-Pak Pail Qty.	Handy-Pak Part No.	Handy-Pak MC Qty./Screw Qty. (per EA)
#8 x 1"					<b>96050</b>	6 / 100
#8 x 1-1/4"	<b>10069</b>	4,000	<b>100069</b>	330	<b>114069</b>	6 / 100
#8 x 1-1/2"	<b>10073</b>	3,000	<b>100073</b>	330	<b>114073</b>	6 / 100
#8 x 1-3/4"	<b>10075</b>	2,000			<b>12075</b>	10 / 100
#8 x 2"	<b>10077</b>	2,000	<b>96077</b>	330	<b>113077</b>	4 / 100
#8 x 2-1/2"	<b>10079</b>	1,500	<b>110079</b>	330	<b>113079</b>	4 / 100
#8 x 2-3/4"					<b>113081</b>	4 / 100
#8 x 3-1/8"	<b>10083</b>	1,000	<b>110083</b>	270	<b>114083</b>	6 / 50

### White Low Profile<sup>™</sup> Cabinet Screws



T-15

#8 x 1-1/4"					<b>120680</b>	6 / 80
#8 x 1-1/2"					<b>120670</b>	6 / 80
#8 x 2-1/2"					<b>120660</b>	6 / 80

- Pro-Paks need to be ordered in multiples of two
- 2" bit included in Pro-Paks



## APPLICATIONS:

- Cabinet Construction & Installations
- Trim & Moulding
- Light-Duty Framing

# TOP STAR™

## ADJUSTABLE SHIM SCREWS



## FOR PLUMB INSTALLATION OF WOODEN DOORS AND WINDOWS. NO MORE SHIMS!

GRK's adjustable Top Star™ shim screw is a screw within a screw that allows you to install wooden doors or windows without the use of shims. The quick and easy system reduces labor and allows for hassle free adjustment to ensure plumb installation.

The 4-point top sleeve provides a secure hold into the frame, while the GRK Star Drive bit is used to make the adjustments needed for a perfect, shim-free installation.

The Top Star's highly-engineered system can be used for installation of wooden doors, windows, insulation, paneling, wall-units, and cabinets.

- **Recessed Star Drive:** Zero stripping, with 6 points of contact
- **4-point 3/8" Diameter Threaded Sleeve** provides a secure hold in your wooden frame
- **Micro-Adjustments** allow for an absolute plumb installation
- **Use with GRK's Top Star™ Crown and T-15 Star Bit System**
- **Zinc Plated** finish for lasting durability
- **For Shim Free Installation** of wooden doors, windows, insulations, paneling, built-in wall units, and cabinets



U.S (Std.) Size (Dia. x Length)	Pro-Pak Part No.	Pro-Pak Pail Qty.
3/8" x 2-1/2"	<b>20157</b>	100
3/8" x 3-1/8"	<b>20161</b>	100

• Pro-Paks need to be ordered in multiples of two

### The Complete Top Star™ System Includes:

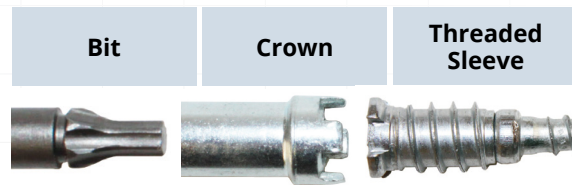

Crown / Bit	Blister-Pak Part No.	Blister-Pak Qty.
Includes: (1) Crown / Bit with each	<b>86465</b>	1

• 5/16" drill bit not included

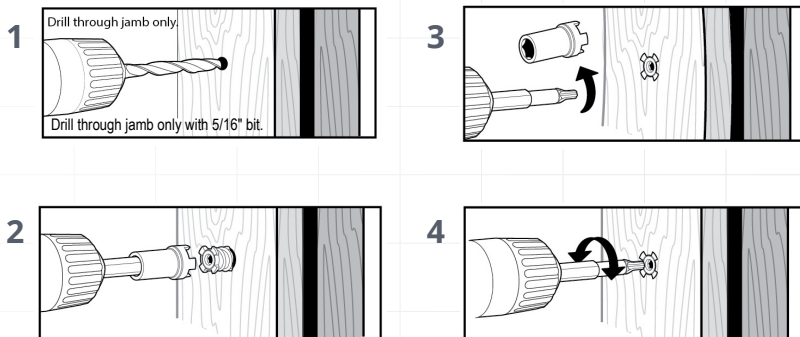

The Bit drives the Top Star™ into the material when the Crown and Bit are combined. Using the Bit without the Crown adjusts the distance.

The Threaded Sleeve moves independently from the Top Star™ unless locked by the Crown. When locked, the Top Star™ gets driven into the material.

Unlocked, the installed Top Star™ is ready for leveling.

## APPLICATIONS:

- Wooden Doors
- Windows
- Insulation



# CALIBURN™ CONCRETE SCREW



## HEAVY DUTY CONCRETE AND MASONRY FASTENER

Caliburn™ Concrete screws are professionally engineered fasteners with a patented thread design for ease of driving the screw into concrete and similar applications.

- **Star Drive Recess:** Zero stripping, with 6 points of contact
- **Aggressive Heavy Duty Threads** lock into concrete and can be removed/reinserted without screw damage
- **Caliburn™ XL:** washer head design for superior holding power
- **Climatek™ Coating:** ICC-ES AC257 code approved for use in treated lumber
- Ideal for use in anchoring to concrete or wood to concrete applications including basement framing and sheds

## APPLICATIONS:

- Wood to Concrete Framing
- Electrical and Plumbing Fixtures
- Caliburn XL for Heavy Duty Concrete Anchoring



U.S (Std.) Size (Dia. x Length)	Bulk Part No.	Bulk Box Qty.	Handy-Pak Part No.	Handy-Pak MC Qty./Screw Qty. (per EA)
<b>Caliburn™ XL</b>				
19/64" x 2-3/4"			<b>57774</b>	10 / 25
19/64" x 3-1/2"	<b>55778</b>	400	<b>57778</b>	10 / 25
19/64" x 5"			<b>57785</b>	10 / 25

• 1" bit included in Handy-Paks

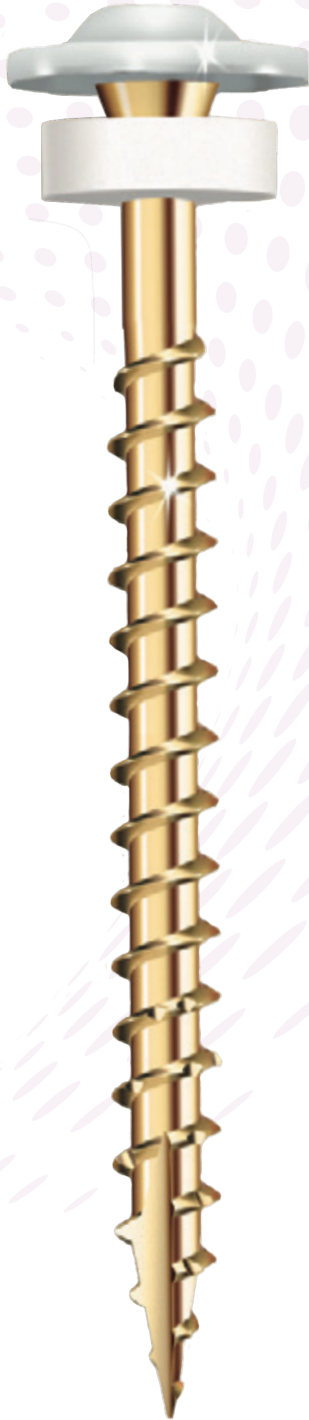

## POWDER COATED HEAD FOR A CLEAN FINISHED LOOK

This screw has an integrated washer-head and is complemented by a rubber washer below the screw head. This feature also helps protect the washer from prolonged exposure to the sun for long lasting, secure siding installations.

- **White Color, Low Profile Head** produces a clean, finished look which is preferred for moldings, closet organizers, and metal siding
- **Washer Head** increases holding power
- **Rubber Washer:** seals drill hole from the elements
- **W-Cut™ Thread Design** tiny saw blades reduce torque by cutting through the material
- **ZIP-TIP™** for easy starts and no pre-drilling
- For use in interior or exterior applications including metal siding, garage door trim, and even closet organizers. Not for use with treated lumber

## APPLICATIONS:

- Metal Siding
- Garage Door Trim
- Closet Organizers



T-25

U.S (Std.) Size (Dia. x Length)	Bulk Part No.	Bulk Box Qty.
#9 x 1-1/2"	40090	3000

- 1" bit included in Handy-Paks

# STAR DRIVE BITS

## CROWN / BIT



Bit Size	Bit Color	Fits	Bulk Part No.	Bulk Box Qty.	Carded Part No.	Carded Qty/per pack
T-10 2" T-10 3"	Yellow Yellow	Trim™ Head #8	86419	25	187419 87421	2 2
T-15 2" T-15 3"	Red Red	R4™ Screw #6 & 8 Trim™ Head #9 Cabinet™ Screw	86427	25	187427 87429	2 2
T-20 2"	Purple		86435	25	187435	2
T-25 2" T-25 3"	Green Green	R4™ #9,10 & 12 RSS™ #10 & 1/4" MSS™ #9	86443	25	187443 87445	2 2
T-30 2" T-30 3"	Black Black	RSS™ Structural Screw 5/16" Caliburn™ & Caliburn PH™	86451	25	187451 87453	2 2
T-40 2"	Blue	Caliburn XL™ Screws RSS™ Structural Screw 3/8"	86459	25	187459	2

Crown/Bit						
		TOP STAR™			86465	1





**STAR DRIVE BITS & ACCESSORIES**



# Tapcon®

 **DRIVING CONCRETE CONNECTIONS**

Tapcon® is the #1 recognized screw anchor brand in the industry. For decades, Tapcon has helped professionals get their concrete anchoring jobs done right the first time, every time.

The blue, corrosion-resistant coating enables our anchors to withstand the harshest conditions, and their unmatched performance (30% less torque and 20% more holding power) in concrete, block and brick applications make them an excellent alternative to expansion anchors, plugs and lag shields.

For quality, strength, and ease of installation, nobody matches the confidence pros get from using the original true blue screw.





# TAPCON®

## CONCRETE SCREW ANCHORS



## NOTHING ANCHORS LIKE A TAPCON.

Tapcon concrete anchors deliver the ease of use, superior precision, and unparalleled performance that professionals demand.

- **Eliminate bit slips** and increase productivity with star recess on flat head Tapcon anchors
- **Resist head snaps** and spin outs with under-head ribs on hex head Tapcon anchors
- **Superior holding strength** for confidence in a job done right
- **Corrosion resistant**, long lasting performance with Climaseal™ coating
- **WERCS threadform** allows for easy installation across a variety of masonry substrates
- **ICC-ES** recognized for use in concrete and masonry (ESR-2202 & ESR-1671)

## APPLICATIONS:

### Star Head

- Furring Strips
- Wood Framing
- Window Frames

### Hex Head

- Electrical Boxes



ESR-1671



ESR-2202





U.S (Std.) Size (Dia. x Length)	Bucket Part No.	Bucket Qty.	Lg. Clam Part No.	Lg. Clam Qty.	Med. Pack Part No.	Med. Pack Qty.	Small Pack Part No.	Small Pack Qty.
<b>STAR HEAD</b>								
3/16" x 1-1/4"	<b>28550</b>	225	<b>28350</b>	75	<b>28250</b>	25	<b>28150</b>	8
3/16" x 1-3/4"	<b>28555</b>	225	<b>28355</b>	75	<b>28255</b>	25	<b>28155</b>	8
3/16" x 2-1/4"	<b>28560</b>	225	<b>28360</b>	75	<b>28260</b>	25	<b>28160</b>	8
3/16" x 2-3/4"	<b>28565</b>	225	<b>28365</b>	75	<b>28265</b>	25	<b>28165</b>	8
3/16" x 3-1/4"			<b>28307</b>	75			<b>28107</b>	8
1/4" x 1-3/4"	<b>28575</b>	225	<b>28375</b>	75	<b>28275</b>	25	<b>28175</b>	8
1/4" x 2-1/4"			<b>28380</b>	75	<b>28280</b>	25	<b>28180</b>	8
1/4" x 2-3/4"	<b>28585</b>	150	<b>28385</b>	75	<b>28285</b>	25	<b>28185</b>	8
1/4" x 3-3/4"			<b>28395</b>	75	<b>28390</b>	25	<b>28295</b>	8
1/4" x 4"			<b>28304</b>	50	<b>28397</b>	25	<b>28204</b>	8
<b>HEX HEAD</b>								
3/16" x 1-1/4"			<b>24300</b>	75	<b>24200</b>	25	<b>24100</b>	8
3/16" x 1-3/4"			<b>24305</b>	75	<b>24205</b>	25	<b>24105</b>	8
3/16" x 2-3/4"			<b>24310</b>	75	<b>24210</b>	25	<b>24110</b>	8
1/4" x 1-1/4"	<b>24515</b>	225	<b>24315</b>	75	<b>24215</b>	25	<b>24115</b>	8
1/4" x 1-3/4"	<b>24520</b>	225	<b>24320</b>	75	<b>24220</b>	25	<b>24120</b>	8
1/4" x 2-1/4"	<b>24525</b>	225	<b>24325</b>	75	<b>24225</b>	25	<b>24125</b>	8
1/4" x 2-3/4"	<b>24530</b>	150	<b>24330</b>	75	<b>24230</b>	25	<b>24130</b>	8
1/4" x 3-1/4"	<b>24501</b>	150	<b>24301</b>	75			<b>24101</b>	8
1/4" x 3-3/4"			<b>24340</b>	75	<b>24335</b>	25		
1/4" x 4"					<b>24345</b>	25		
<b>WHITE ULTRASHIELD TAPCON</b>								
3/16" x 1-3/4"			<b>28371</b>	75			<b>28171</b>	8
3/16" x 2-1/4"			<b>28372</b>	75			<b>28172</b>	8
3/16" x 2-3/4"			<b>28367</b>	75	<b>28267</b>	25	<b>28167</b>	8
1/4" x 2-3/4"			<b>24388</b>	75	<b>24288</b>	25	<b>24188</b>	8
1/4" x 3-1/4"			<b>24391</b>	75				
1/4" x 3-3/4"			<b>24392</b>	75				
<b>410 STAINLESS STEEL TAPCON</b>								
3/16" x 1-3/4"							<b>26155</b>	8
3/16" x 2-3/4"							<b>26165</b>	8
1/4" x 1-3/4"							<b>26120</b>	8
1/4" x 2-3/4"							<b>26130</b>	8
<b>MAXI-SET TAPCON</b>								
1/4" x 2-1/4"			<b>24326</b>	50				
1/4" x 2-1/4"			<b>24323</b>	50				
<b>TAPCON DRILL BITS</b>								
5/32" x 3-1/2"							<b>11256</b>	1
5/32" x 4-1/2"							<b>11247</b>	1
5/32" x 5-1/2"					<b>11249</b>	4	<b>11363</b>	1
3/16" x 3-1/2"							<b>11257</b>	1
3/16" x 4-1/2"							<b>11248</b>	1
3/16" x 5-1/2"					<b>11250</b>	4	<b>11362</b>	1
5/32" x 7" SDS							<b>11492</b>	1
3/16" x 7" SDS							<b>11491</b>	1
1/4" x 7" SDS							<b>11493</b>	1
3/8" x 8" SDS							<b>11494</b>	1
1/2" x 10" SDS							<b>11495</b>	1
<b>TAPCON PRO INSTALLATION KIT</b>								
Tapcon Pro Install Tool							<b>79013</b>	1

TAPCON® CONCRETE SCREW ANCHORS

# TAPCON+®

## HEAVY DUTY CONCRETE SCREW ANCHORS



### STRONGER. FASTER. EASIER.

Tapcon+ unmatched performance in concrete, block and brick applications make them an excellent alternative to expansion anchors, plugs, lag shields and have a blue corrosion resistant coating that enables them to withstand the harshest conditions. That's why when pros look for quality, strength and ease of installation, they choose Tapcon.

- **ICC-ES Approved** for use in uncracked & cracked concrete and seismic conditions (ESR-3699)
- **Heavy-Duty Holding Power** in all concrete conditions
- **Flexibility:** to install closer to the edge & closer together with confidence
- **Precision Fit:** A long-standing reputation for quality, strength, and ease of installation from industry professionals



ESR-3699

U.S (Std.) Size (Dia. x Length)	Pro-Pak Part No.	Pro-Pak Qty.	Handy-Pak Part No.	Pro-Pak Pail Qty.	Small Pack Part No.	Small Pack Qty.
5/16" x 2-1/4"			<b>24292</b>	15	<b>24192</b>	4
5/16" x 3"			<b>24293</b>	15	<b>24193</b>	4
3/8" x 1-3/4"	<b>11440</b>	10			<b>50440</b>	2
3/8" x 2-1/4"	<b>11441</b>	10			<b>50441</b>	2
3/8" x 3"	<b>11413</b>	10			<b>50403</b>	2
3/8" x 4"	<b>11414</b>	10			<b>50404</b>	2
3/8" x 5"					<b>50445</b>	2
3/8" x 6"					<b>50446</b>	2
1/2" x 3"	<b>11447</b>	10			<b>50447</b>	2
1/2" x 4"	<b>11420</b>	10			<b>50408</b>	2
1/2" x 5"	<b>11449</b>	10			<b>50449</b>	2
1/2" x 6"	<b>11421</b>	10			<b>50426</b>	2



## APPLICATIONS:

- Sill Plates
- Post Cap Connector
- Ledger Board
- Heavy Equipment
- Industrial Racking/Shelving
- Modular Walls
- Machinery

# Trubolt WEDGE ANCHORS

## HEAVY DUTY CONCRETE ANCHORS



## MAXIMUM STRENGTH FOR HEAVY-DUTY CONCRETE ANCHORING

Trubolt Wedge Anchors offer maximum strength and ultimate flexibility making them the PRO choice for heavy-duty anchoring. This wedge anchor features a high-strength body that is built to resist tension and shear loads.

- **ICC-ES Approved** for use in uncracked concrete (ICC-ES-ESR-2251)
- **Heavy-Duty Holding Power** in concrete conditions
- **Fully Threaded Anchor Design** for application versatility
- **Stainless Steel Clip** provides extra corrosion protection
- A long standing reputation for quality, strength, and ease of installation from industry professionals



ESR-2251

U.S (Std.) Size (Dia. x Length)	Pro-Pak Part No.	Pro-Pak Qty.	Handy-Pak Part No.	Handy-Pak Pail Qty.	Poly-Bag Part No.	Poly-Bag Qty.
1/4" x 2-1/4"			<b>12377</b>	25	<b>50080</b>	1
3/8" x 2-1/4"	<b>12367</b>	50	<b>12015</b>	15	<b>50081</b>	1
3/8" x 3"	<b>03014</b>	50			<b>50082</b>	1
3/8" x 3-3/4"	<b>12370</b>	50	<b>12016</b>	15	<b>50083</b>	1
3/8" x 5"			<b>12022</b>	15	<b>50084</b>	1
1/2" x 2-3/4"					<b>50085</b>	1
1/2" x 3-3/4"	<b>12371</b>	25	<b>12017</b>	10	<b>50181</b>	1
1/2" x 4-1/4"	<b>12372</b>	25	<b>12020</b>	10	<b>50086</b>	1
1/2" x 5-1/2"	<b>12373</b>	25	<b>12019</b>	10	<b>50087</b>	1
1/2" x 7"					<b>50088</b>	1
5/8" x 5"	<b>12310</b>	10			<b>50089</b>	1
5/8" x 6"	<b>03041</b>	10				
5/8" x 7"	<b>03044</b>	10			<b>51030</b>	1
5/8" x 8-1/2"					<b>50305</b>	1
3/4" x 5-1/2"	<b>02992</b>	10			<b>51001</b>	1
<b>HOT-DIPPED GALVANIZED</b>						
1/2" x 5-1/2" HDG			<b>12021</b>	10	<b>50303</b>	1
1/2" x 7" HDG	<b>12029</b>	10			<b>50307</b>	1



## APPLICATIONS:

- Machinery
- Sill plate installation

# RED HEAD® CONCRETE ANCHORS

## CONCRETE ANCHORS



**SLEEVE ANCHOR**

## VERSATILE ANCHORING SOLUTIONS FOR CONCRETE & BUILDING

Red Head can help you get any job done right, from heavy-duty ceiling applications to light-duty work in block and brick.

Our sleeve anchor is our most versatile anchor with the ability to fasten in block, brick, masonry, and solid concrete.

For a lighter duty project, Poly-Set and Hammer-Set are great choices for block, brick and concrete and allow for a quick and easy installation. For heavy-duty overhead applications, use our Drop-In anchors. Use the complete family of anchors and SDS bits to ensure precise hole depth and diameter when using our anchors.



**POLY-SET**



**HAMMER-SET**



**DROP-IN**

U.S (Std.) Size (Dia. x Length)	Pro-Pak Part No.	Pro-Pak Qty.	Handy-Pak Part No.	Handy-Pak Pail Qty.	Poly-Bag Part No.	Poly-Bag Qty.
<b>SLEEVE ANCHORS</b>						
1/4" x 2-1/4" Acorn Hd					<b>50122</b>	1
1/4" x 2-1/4" Threshold Hd					<b>50123</b>	1
1/4" x 3-1/8" Flat Hd					<b>50121</b>	1
5/16" x 1-1/2" Hex Hd					<b>50112</b>	1
5/16" x 2-1/2" Hex Hd					<b>50113</b>	1
3/8" x 1-7/8" Hex Hd					<b>50114</b>	1
3/8" x 3" Hex Hd	<b>11281</b>	50	<b>11013</b>	15	<b>50115</b>	1
1/2" x 2-1/4" Hex Hd					<b>50116</b>	1
1/2" x 3" Hex Hd	<b>11283</b>	25	<b>11014</b>	10	<b>50117</b>	1
1/2" x 4" Hex Hd	<b>11285</b>	25	<b>11018</b>	10	<b>50118</b>	1
5/8" x 4-1/4" Hex Hd					<b>50119</b>	1
5/8" x 6" Hex Hd					<b>50120</b>	1
<b>POLY-SET ANCHORS</b>						
1-1/4"			<b>35220</b>	50		
1-7/16"			<b>35225</b>	50		
<b>HAMMER-SET ANCHORS</b>						
1/4" x 1"	<b>35300</b>	75	<b>35200</b>	25		
1/4" x 1-1/2"	<b>35303</b>	50	<b>35203</b>	15		
1/4" x 2"	<b>35305</b>	50	<b>35205</b>	15		
1/4" x 3"	<b>35207</b>	25				
<b>DROP-IN ANCHORS</b>						
3/8" Anchor	<b>01891</b>	50			<b>50125</b>	1
1/2" Anchor					<b>50126</b>	1
3/8" Setting Tool					<b>07499</b>	1
1/2" Setting Tool					<b>07501</b>	1



## APPLICATIONS:

- Conduit Clips
- Drywall tracks
- Curtain rods
- Shelving
- Shelf Ledgers
- Racking
- Secure Transformers
- Light Fixtures

# A7+ ADHESIVE ANCHORS

## HIGH STRENGTH ADHESIVE ANCHORING SOLUTION



## CONCRETE ANCHORING AND REINFORCING SOLUTIONS

For jobs requiring versatility, high performance, and efficiency, Red Head's A7+ Concrete Adhesive Anchor is the one anchoring solution that does it all. A7+ takes only 45 minutes to fully cure and can be used in challenging conditions like cold temperatures and water-filled holes. A7+ is also ICC-ES approved for cracked concrete and seismic building code requirements.

- **ICC-ES approved** For use in cracked concrete and seismic conditions (ICC-ES-ESR-3903)
- **Quick 45 minute cure time** for fast installation
- **Easy dispensing** with a standard caulk gun, eliminating the need for any special tools
- Increased productivity with a successful cure in saturation concrete and water-filled holes
- A long-standing reputation for quality, strength, and ease of installation from industry professionals.



ESR-3903



ESR-3951



A7+ can also be used in any standard medium-duty caulk gun, eliminating the inconvenience of needing a special dispensing tool. Combine the simplicity of dispensing with the quick-curing product, and installation is fast, easy, and doesn't take time away from the rest of the project.

The A7+ concrete adhesive anchoring solution is a high-performing anchor that rivals other products on the market in both price and features. This high performance and efficiency allows for less time on the job and more productivity.

Providing code approved performance and a fast 45 minute cure time, Red Head A7+ is the concrete anchoring adhesive that delivers.

U.S (Std.) Size (Dia. x Length)	Part No.	Qty.
9.5 oz. Cartridge	07111	1



## APPLICATIONS:

For use in:

- Concrete
- Grout-filled and hollow brick
- Clay tile

# RAMSET® TOOLS AND FASTENERS

## POWDER ACTUATED TOOLS FOR RESIDENTIAL AND COMMERCIAL REMODELING



Cobra+



MasterShot



TriggerShot



HammerShot

## DURABLE. STURDY. POWERFUL.

From concrete to steel, Ramset has the tool to help you get the job done on time. Ramset is designed with speed and productivity in mind. With innovating solutions we provide you with the best anchoring experience.

- Powder actuated tools for concrete or steel
- Drives job sit speed through quick and efficient fastening
- Market leading tool innovations help you get the job done right
- The Powder Actuated Tool choice for PROs

Item/Tool	Part No.	Qty.
<b>Cobra+</b> .27 Caliber Semi-Automatic Powder Actuated Tool	<b>16942</b>	1
<b>MasterShot</b> .22 Caliber Single-Shot Powder Actuated Tool	<b>40088</b>	1
<b>TriggerShot</b> .22 Caliber Single-Shot Powder Actuated Tool	<b>40066</b>	1
<b>HammerShot</b> .22 Caliber Single-Shot Powder Actuated Tool	<b>00022</b>	1



ESR-1799



ESR-2690

U.S (Std.) Size (Dia. x Length)	Pro-Pak Part No.	Pro-Pak Qty.	Handy-Pak Part No.	Handy-Pak Pail Qty.				
<b>DRIVE PINS</b>								
.300 x 1/2"	<b>06171</b>	100						
.300 x 3/4"	<b>00747</b>	100						
.300 x 1"	<b>00759</b>	100						
.300 x 1-1/2"	<b>00774</b>	100						
.300 x 2"	<b>00780</b>	100						
.300 x 2-1/2"	<b>00786</b>	100	<b>00787</b>	25				
.300 x 3"	<b>00794</b>	100						
<b>DRIVE PINS WITH WASHERS</b>								
.300 x 1"	<b>00797</b>	100						
.300 x 1-1/2"	<b>00803</b>	100	<b>00804</b>	25				
.300 x 1-1/4"	<b>00800</b>	100						
.300 x 2"	<b>00806</b>	100						
.300 x 2-1/2"	<b>00809</b>	100	<b>00810</b>	15				
.300 x 3"	<b>07886</b>	100	<b>07887</b>	15				
<b>RAMGUARD DRIVE PINS FOR USE IN TREATED LUMBER</b>								
.300 x 2-1/2"	<b>09167</b>	100						
.300 x 2-1/2" with Washers	<b>09173</b>	100						
.300 x 3" with Washers	<b>09176</b>	100						
Caliber	Color	Type	Strip Load Part No.	Qty.	Single Shot Box Pt. #	Single Shot Box Qty.	Single Shot Blister pt.#	Single Shot Blister Qty.
.22	Brown	Powder			<b>00594</b>	100		
.22	Green	Powder			<b>00601</b>	100		
.22	Yellow	Powder			<b>00607</b>	100	<b>50077</b>	25
.27	Green	Strip	<b>00652</b>	100				
.27	Yellow	Strip	<b>00667</b>	100				
.27	Red	Strip	<b>00682</b>	100				



## APPLICATIONS:

- 2 x 4 framing
- Furring strips
- Attaching electrical boxes

# TEKS® METAL FASTENERS

## METAL TO METAL SCREWS AND WOOD TO METAL SCREWS



### SECURELY FASTEN METAL WITH SPEED

Teks® fasteners are offered in sharp and drill points that easily penetrate light to heavy gauge metal and wood. Professionals no longer have to struggle when engaging their work surface.

Teks® fasteners are offered in a wide variety of head styles to meet professionals installation needs. No tool slippage or cam-outs even with old sockets and worn bits. Professionals can drill, tap, and fasten – all in one motion.

- **Drive surface and recess:** Reduces cam-outs to prevent slipping during installation
- **Drill Points:** Self-drills through light to heavy gauge metal with ease
- **Sharp Points:** Self-pierces into light gauge metal to start drilling faster
- **Self-Tapping Threads:** Taps their own threads to provide less effort when fastening into metal
- **Corrosion Resistant Finish:** Protects the job's appearance with long lasting coating
- **Reamer Wings:** Winged screws self-drill into wood and engage metal to provide a secure hold

### APPLICATIONS



#### WOOD TO METAL:

- Attaching roof/subfloor decking
- Trailer beds to frame
- Wood headers to steel frame



#### METAL TO METAL:

- Attaching HVAC
- Electrical
- Metal framing
- General metal to metal applications

U.S (Std.) Size (Dia. x Length)	Pro-Pak Part No.	Pro-Pak Pail Qty.	Handy-Pak Part No.	Handy-Pak Ctn. Size/Qty.
<b>TEKS® METAL TO METAL SCREWS</b>				
<b>HEX WASHER HEAD / DRILL POINT ( METAL TO METAL )</b>				
8 x 1/2"			<b>21308</b>	S/280
8 x 3/4"			<b>21312</b>	S/180
8 x 1"			<b>21316</b>	S/170
10 x 5/8"			<b>21396</b>	S/170
10 x 3/4"	<b>21322</b>	450	<b>21320</b>	S/150
10 x 1"			<b>21328</b>	M/140
10 x 1-1/2"			<b>21332</b>	M/90
12 x 3/4"			<b>21336</b>	M/120
12 x 1"	<b>21341</b>	400	<b>21340</b>	M/100
12 x 1-1/2"			<b>21344</b>	M/80
12 x 2"			<b>21348</b>	M/60
12/14 x 2"			<b>21820</b>	M/60
14 x 3/4"			<b>21349</b>	S/100
14 x 1"			<b>21351</b>	S/60
14 x 1-1/2"			<b>21352</b>	M/50
14 x 2-1/2"	<b>21358</b>	120	<b>21356</b>	M/30
<b>HEX WASHER HEAD / SHARP POINT ( METAL TO METAL )</b>				
6 x 1/2"			<b>21301</b>	S/320
8 x 1-1/2"			<b>21318</b>	M/85
10 x 3/4"			<b>21327</b>	M/150
<b>PAN HEAD / DRILL POINT ( METAL TO METAL )</b>				
8 x 1/2"			<b>21360</b>	S/300
8 x 3/4"			<b>21364</b>	S/240
10 x 3/4"			<b>21372</b>	S/170
<b>PAN HEAD / SHARP POINT ( METAL TO METAL )</b>				
6 x 1/2"			<b>21359</b>	S/300
<b>PANCAKE HEAD / DRILL POINT ( METAL TO METAL )</b>				
10 x 5/8"			<b>21376</b>	S/190
<b>TEKS® WOOD TO METAL SCREWS</b>				
<b>PHILLIPS FLAT HEAD / DRILL POINT W/REAMER WINGS ( WOOD TO METAL )</b>				
1/4-20 x 3"			<b>21378</b>	M/40
10 x 1-7/16"	<b>21381</b>	300	<b>21380</b>	S/100
12 x 2-3/4"	<b>21386</b>	200	<b>21384</b>	S/40

# TEKS® METAL FASTENERS

## ROOFING SCREWS AND LATH SCREWS



Teks Roofing Screws provide secure fastening with strong holding power, without the need to pre-drill.

- Self-sealing neoprene washer provides a waterproof seal
- Premium finish provides exceptional corrosion resistance in harsh outdoor environments



Teks Lath Screws provide secure metal-to-metal and metal-to-wood fastening with strong holding power, without the need to pre-drill.

- Lath head: Lath Screws feature a low-profile head for a semi-flush finish for virtually any application
- Self-tapping threads ensure strong holding power
- Zinc plated finish protects the job's appearance. resistance in harsh outdoor environments

## APPLICATIONS



### ROOFING SCREWS:

- Ideal for attaching roofing
- Wall panels
- Steel and wood framing.



### LATH SCREWS:

- Attaching lath to wood or steel studs for stucco/plaster applications
- Attaching pre-drilled metal brackets to post-framing
- Any general applications requiring a wide, low-profile head

U.S (Std.) Size (Dia. x Length)	Pro-Pak Part No.	Pro-Pak Pail Qty.	Handy-Pak Part No.	Handy-Pak Ctn. Size/Qty.
<b>TEKS® ROOFING SCREWS</b>				
<b>EX WASHER HEAD / SHARP POINT ( METAL TO WOOD )</b>				
9 x 1"	<b>21401</b>	360	<b>21400</b>	M/120
9 x 1-1/2"	<b>21406</b>	400	<b>21404</b>	M/100
<b>HEX WASHER HEAD / DRILL POINT ( METAL TO METAL )</b>				
12 x 3/4"			<b>21408</b>	M/90
12 x 1"	<b>21418</b>	400	<b>21412</b>	M/80
12 x 1-1/2"	<b>21422</b>	300		
<b>TEKS® LATH SCREWS</b>				
<b>MODIFIED TRUSS HEAD / SHARP POINT ( METAL TO METAL )</b>				
8 x 1/2"			<b>21500</b>	S/260
8 x 3/4"	<b>21506</b>	600	<b>21504</b>	S/200
8 x 1"	<b>21510</b>	510	<b>21508</b>	S/170
8 x 1-1/4"			<b>21512</b>	M/140
8 x 1-5/8"			<b>21516</b>	M/120
8 x 2"			<b>21518</b>	M/100
8 x 2-1/2"			<b>21519</b>	M/80
<b>MODIFIED TRUSS HEAD / DRILL POINT ( METAL TO METAL )</b>				
8 x 1/2"			<b>21520</b>	S/260
8 x 3/4"	<b>21525</b>	600	<b>21524</b>	S/200
8 x 1"	<b>21530</b>	510	<b>21528</b>	S/170
8 x 1-1/4"			<b>21532</b>	M/140
8 x 1-5/8"			<b>21536</b>	M/120
8 x 2"			<b>21538</b>	M/100
8 x 2-1/2"			<b>21540</b>	M/80

# BACKER-ON<sup>®</sup>, ROCK-ON<sup>®</sup>

## CEMENT BOARD SCREWS

### CEMENT BOARDS FASTENED RIGHT

Backer-On<sup>®</sup> cement screws are designed for attaching HardieBacker<sup>®</sup> cement board and Rock-On<sup>®</sup> cement board screws are designed for attaching Durock<sup>®</sup> cement board to wood or light gauge steel studs. The patented serrated head design countersinks for a flush finish even at angle, providing a smooth surface for tile installation. The T-25 Star Drive recess provides Stikfit™ for one-handed installation. Climacoat corrosion resistant finish prevents rust from bleeding into grout. Making it perfect for use in high moisture areas such as bathrooms and kitchens.

Backer-On<sup>®</sup> and Rock-On<sup>®</sup> cement board screws comply with ANSI standards for cement board installation as specified by cement board manufacturers. Cement board manufacturers require ANSI compliance in order to remain eligible for warranty.

- **Serrated Head:** Designed to drive flush even at an angle
- **Star Drive with T-25 Bit:** Provides Stikfit™ for easy one-handed installation and eliminates cam-outs
- **Hi-Lo / Single Threads:** Starts quickly and drives smooth in cement boards
- **Sharp Points:** Offers immediate pick-up and eliminates the need to pre-drill
- **Climacoat Finish:** Corrosion resistant for preventing rust from bleeding into tile





U.S (Std.) Size (Dia. x Length)	Pro-Pak Part No.	Pro-Pak Pail Qty.	Handy-Pak Part No.	Handy-Pak Ctn. Size/Qty.
<b>BACKER-ON® SCREWS</b>				
#9 x 1-1/4"	<b>23406</b>	750	<b>23401</b>	M/185
#9 x 1-5/8"	<b>23416</b>	575	<b>23411</b>	M/140
#9 x 2-1/4"			<b>23421</b>	M/100
<b>ROCK-ON® SCREWS</b>				
#9 x 1-1/4"	<b>23306</b>	750	<b>23301</b>	M/185
#9 x 1-5/8"	<b>23316</b>	575	<b>23311</b>	M/140
#9 x 2-1/4"			<b>23321</b>	M/100

<b>BACKER-ON® / ROCK-ON® StikFit Bit</b>		
Size Point	Part No.	Carded Quantity / Per Pack
#T-25 2"	<b>24000</b>	( 2 ) StikFit Bits

The **T-25 StikFit Bits** modified tip eliminates wobble and offers one-handed installation only for Backer-On/Rock-On cement board screws. The bits are made with S2 modified steel for long lasting bit life.

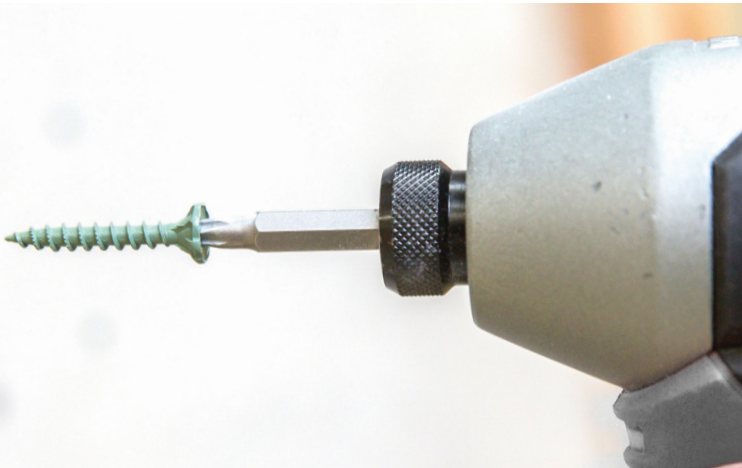

## APPLICATIONS:

- Attaching fiber cement board to wood or light gauge steel framing
- Attaching fiberglass reinforced cement board to wood or light gauge steel framing

**Pro Tip:** Standard roofing nails, dry wall screws, and other alternatives to cement board screws are typically not specified by cement board manufacturers and not ANSI compliant.



**E-Z Anchor® Twist-N-Lock**



**E-Z Anchor® Stud Solver**



**E-Z Anchor® Toggle Lock**

## EASY TO INSTALL WITH STRONG HOLDING POWER

**E-Z Anchors®** are ideal for hanging accessories, signs, fixtures, and shelving units on drywall. Designed to self-drill flush into drywall for easy and fast installations. No pre-drilling necessary. The threads are formed to provide increased stability and a secure hold.

**E-Z Anchor® Twist-N-Lock** is designed for light to medium-duty applications. The audible click provides confirmation of the anchor being firmly set. Threads cut deeply to resist pull-out and provide a secure hold.

**E-Z Anchor® Stud Solver** is designed for light to medium-duty applications. Installs anywhere on a wall, even if you hit a wood stud behind the drywall. Threads cut deeply to resist pull-out and provide a secure hold.

**E-Z Anchor® Toggle Lock** is designed for heavy-duty drywall applications. The superior 1-piece assembly prevents losing extra pieces behind the wall. The toggle bar swivels easily during assembly to provide a secure hold.

**Buildex® Stucco Anchor** is designed for light to medium-duty applications in stucco. The zinc plating is designed to be durable in exterior and interior applications. Kits include a drill bit for installation.

- **No Pre-Drilling:** Screws directly into drywall with a Phillips screwdriver
- **Self-Piercing Point:** Positions anchor in desired location without slipping and starts self-drilling faster
- **Clean Finish:** Installs flush into drywall
- **Strong Holding Power:** Prevents loose connections and items from wobbling



U.S (Std.) Size (Max Load)	Lg. Pack Part No.	Lg. Pack Qty.	Med. Pack Part No.	Med Pack Qty.	Small Pack Part No.	Small Pack Qty.
<b>E-Z ANCOR TWIST-N-LOCK ANCHORS</b>						
50 lbs.	25350	50	25200	25	11353	6
75 lbs.	25310	50	25210	20	11364	4
<b>E-Z ANCOR STUD SOLVER ANCHORS</b>						
40 lbs.	25325	50	25225	25	25125	4
50 lbs.	25316	50	25216	20	29503	5
<b>E-Z ANCOR / E-Z TOGGLE LOCK ANCHOR</b>						
100 lbs.	25320	25	25220	10	10006	2
<b>BUILDEX® STUCCO ANCHORS</b>						
3/16"x 1-1/2"Hex Hd			31810	25	31710	4
3/16"x 1-1/2"Flat Hd			31820	25	31720	4
1/4"x 2-7/8"			31840	25	31740	4

<b>E-Z ANCOR CONTRACTOR PACKS</b>		
U.S (Std.) Size (Max Load)	Contractor Pack Part No.	Contractor Pack Qty.
<b>E-Z ANCOR CONTRACTOR TWIST-N-LOCK ANCHORS</b>		
75 lbs.	25410	100
<b>E-Z ANCOR CONTRACTOR STUD SOLVER ANCHORS</b>		
50 lbs.	25616	100
<b>E-Z ANCOR TWIST-N-LOCK AND STUD SOLVER ANCHORS COMBO</b>		
50 lbs./75 lbs.	25600	25/25

**Warning:** Do not use Twist-N-Lock or Stud Solver anchors for ceiling applications. Do not use for mounting televisions. Load ratings are for items hung flush to the wall. Load ratings decrease when hanging items that project from the wall.



## APPLICATIONS:

For Mounting:

- Picture Frames
- Shelving
- Mounting Brackets
- Hooks
- And more

E-Z ANCOR® DRYWALL ANCHORS



## ***LIABILITY AND WARRANTIES***

GRK Fasteners™ (“GRK”) is a distributor of commercial-grade fasteners. The parts that we supply are quality inspected by independent labs.

We maintain lot traceability on all products listed in this catalog as long as they are in their original bulk boxes. Certifications are maintained on all fasteners.

**Hydrogen Embrittlement:** GRK takes measures during production of all fasteners to mitigate hydrogen embrittlement, including post-coating baking. These processes, however, do not guarantee that hydrogen embrittlement will not still be present or that it will not occur at a later date while in service. Specialized testing or a substitute part may be required, depending on the application.

**GRK Warranty:** GRK warrants to the first retail purchaser that its Climatek™ coated, Deck Elite coated, and PHEINOX™ stainless steel screws will not rust under normal environmental conditions when used in accordance with the recommendations listed in this catalog. This warranty is not transferable. Visit [www.grkfasteners.com](http://www.grkfasteners.com) for more information.

## ***LIABILITY AND WARRANTIES***

**Mechanical Fastening Warranty:** (Includes GRK Fasteners, Tapcon, Red Head, Ramset, Teks, Rock-On, Backer-On, and E-Z Anchor). ITW Brands warrants that these products are free from defects in material and workmanship. ITW Brands's sole liability for any breach of this warranty shall be to replace this product or refund the purchase price.

**Liability:** Claims against GRK or ITW Brands shall be limited to a refund or credit for the price billed or paid for faulty or incorrect merchandise. Seller shall not be responsible for buyer's manufacturing costs, labor, alternate purchases, extra freight, replating, plating, lost profit, good will, recall costs, or other incidental or consequential damages.

**Refunds/Replacements:** In order to request a refund or replacement, please contact ITW Customer Service at BrandsCS@itwbrands.com or 877 489-2726 to start the process.

**THERE ARE NO UNDERSTANDINGS, AGREEMENTS, REPRESENTATIONS, OR ADDITIONAL WARRANTIES, EXPRESSED OR IMPLIED (INCLUDING ANY REGARDING WARRANTIES OF MERCHANTABILITY OR FITNESS FOR A PARTICULAR PURPOSE), NOT SPECIFIED HEREIN, RESPECTING ANY SALE OF PRODUCTS BY GRK FASTENERS™ (TO THE EXTENT PERMITTED BY LAW).**





[paslode.com](http://paslode.com)



[grkfasteners.com](http://grkfasteners.com)



[tapcon.com](http://tapcon.com)



[backeronrockon.com](http://backeronrockon.com)



[ramset.com](http://ramset.com)



[teksscrews.com](http://teksscrews.com)



[redheadanchoring.com](http://redheadanchoring.com)



[easyanchors.com](http://easyanchors.com)

# FULL-LINE CATALOG



Part #99915  
August 2022

ITW CONSTRUCTION | RESIDENTIAL AND RENOVATION  
Glenview, IL 60025